

Hypertherm[®]

Powermax125[®]

Plasma Arc Cutting System



Operator Manual

808080 | Revision 3.1 | English

Register your new Hypertherm system

Register your product online at www.hypertherm.com/registration for easier technical and warranty support. You can also receive updates on new Hypertherm products and a free gift as a token of our appreciation.

For your records

Serial number: _____

Purchase date: _____

Distributor: _____

Maintenance notes:

Powermax, Duramax, Smart Sense, FastConnect, FineCut, and Hypertherm are trademarks of Hypertherm Inc. and may be registered in the United States and other countries. All other trademarks are the property of their respective holders.

One of Hypertherm's long-standing core values is a focus on minimizing our impact on the environment. Doing so is critical to our, and our customers', success. We are always striving to become better environmental stewards; it is a process we care deeply about.

Powermax125

Operator Manual

808080
Revision 3.1

English

January 2026

Hypertherm Inc.
Hanover, NH 03755 USA
www.hypertherm.com

Hypertherm Inc.

Etna Road, P.O. Box 5010
Hanover, NH 03755 USA
603-643-3441 Tel (Main Office)
603-643-5352 Fax (All Departments)
info@hypertherm.com (Main Office Email)

800-643-9878 Tel (Technical Service)

technical.service@hypertherm.com (Technical Service Email)

800-737-2978 Tel (Customer Service)

customer.service@hypertherm.com (Customer Service Email)

866-643-7711 Tel (Return Materials Authorization)**877-371-2876 Fax (Return Materials Authorization)**

return.materials@hypertherm.com (RMA email)

Hypertherm México, S.A. de C.V.

Avenida Toluca No. 444, Anexo 1,
Colonia Olivar de los Padres
Delegación Álvaro Obregón
México, D.F. C.P. 01780
52 55 5681 8109 Tel
52 55 5683 2127 Fax
Soporte.Tecnico@hypertherm.com (Technical Service Email)

Hypertherm Plasmatechnik GmbH

Sophie-Scholl-Platz 5
63452 Hanau
Germany
00 800 33 24 97 37 Tel
00 800 49 73 73 29 Fax

31 (0) 165 596900 Tel (Technical Service)**00 800 4973 7843 Tel (Technical Service)**

technicalservice.emea@hypertherm.com (Technical Service Email)

Hypertherm (Singapore) Pte Ltd.

82 Genting Lane
Media Centre
Annexe Block #A01-01
Singapore 349567, Republic of Singapore
65 6841 2489 Tel
65 6841 2490 Fax
Marketing.asia@hypertherm.com (Marketing Email)
TechSupportAPAC@hypertherm.com (Technical Service Email)

Hypertherm Japan Ltd.

Level 9, Edobori Center Building
2-1-1 Edobori, Nishi-ku
Osaka 550-0002 Japan
81 6 6225 1183 Tel
81 6 6225 1184 Fax
HTJapan.info@hypertherm.com (Main Office Email)
TechSupportAPAC@hypertherm.com (Technical Service Email)

Hypertherm Europe B.V.

Vaartveld 9, 4704 SE
Roosendaal, Nederland
31 165 596907 Tel
31 165 596901 Fax
31 165 596908 Tel (Marketing)
31 (0) 165 596900 Tel (Technical Service)
00 800 4973 7843 Tel (Technical Service)
technicalservice.emea@hypertherm.com
(Technical Service Email)

Hypertherm (Shanghai) Trading Co., Ltd.

B301, 495 ShangZhong Road
Shanghai, 200231
PR China
86-21-80231122 Tel
86-21-80231120 Fax
86-21-80231128 Tel (Technical Service)
techsupport.china@hypertherm.com
(Technical Service Email)

South America & Central America: Hypertherm Brasil

Rua Bras Cubas, 231 – Jardim Maia
Guarulhos, SP – Brasil
CEP 07115-030
55 11 2409 2636 Tel
tecnico.sa@hypertherm.com (Technical Service En

Hypertherm Korea Branch

#3904. APEC-ro 17. Heaundae-gu. Busan.
Korea 48060
82 (0)51 747 0358 Tel
82 (0)51 701 0358 Fax
Marketing.korea@hypertherm.com (Marketing Ema
TechSupportAPAC@hypertherm.com
(Technical Service Email)

Hypertherm Pty Limited

GPO Box 4836
Sydney NSW 2001, Australia
61 (0) 437 606 995 Tel
61 7 3219 9010 Fax
au.sales@Hypertherm.com (Main Office Email)
TechSupportAPAC@hypertherm.com
(Technical Service Email)

Hypertherm (India) Thermal Cutting Pvt. Ltd

A-18 / B-1 Extension,
Mohan Co-Operative Industrial Estate,
Mathura Road, New Delhi 110044, India
91-11-40521201/ 2/ 3 Tel
91-11 40521204 Fax
HTIndia.info@hypertherm.com (Main Office Email)
TechSupportAPAC@hypertherm.com
(Technical Service Email)

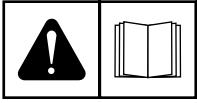

ENGLISH

WARNING! Before operating any Hypertherm equipment, read the safety instructions in your product's manual and in the *Safety and Compliance Manual* (80669C). Failure to follow safety instructions can result in personal injury or in damage to equipment.

Copies of the manuals may accompany the product in electronic and printed formats. You can also obtain copies of the manuals, in all languages available for each manual, from the "Documents library" at www.hypertherm.com.

DEUTSCH / GERMAN

WARNUNG! Bevor Sie ein Hypertherm-Gerät in Betrieb nehmen, lesen Sie bitte die Sicherheitsanweisungen in Ihrer Bedienungsanleitung sowie im *Handbuch für Sicherheit und Übereinstimmung* (80669C). Das Nichtbefolgen der Sicherheitsanweisungen kann zu Verletzungen von Personen oder Schäden am Gerät führen.

Bedienungsanleitungen und Handbücher können dem Gerät in elektronischer Form oder als Druckversion beiliegen. Alle Handbücher und Anleitungen können in den jeweils verfügbaren Sprachen auch in der „Dokumente-Bibliothek“ unter www.hypertherm.com heruntergeladen werden.

FRANÇAIS / FRENCH

AVERTISSEMENT! Avant d'utiliser tout équipement Hypertherm, lire les consignes de sécurité importantes dans le manuel de votre produit et dans le *Manuel de sécurité et de conformité* (80669C). Le non-respect des consignes de sécurité peut engendrer des blessures physiques ou des dommages à l'équipement.

Des copies de ces manuels peuvent accompagner le produit en format électronique et papier. Vous pouvez également obtenir des copies de chaque manuel dans toutes les langues disponibles à partir de la « Bibliothèque de documents » sur www.hypertherm.com.

ESPAÑOL / SPANISH

¡ADVERTENCIA! Antes de operar cualquier equipo Hypertherm, leer las instrucciones de seguridad del manual de su producto y del *Manual de Seguridad y Cumplimiento* (80669C). No cumplir las instrucciones de seguridad podría dar lugar a lesiones personales o daño a los equipos.

Pueden venir copias de los manuales en formato electrónico e impreso junto con el producto. También se pueden obtener copias de los manuales, en todos los idiomas disponibles para cada manual, de la "Biblioteca de documentos" en www.hypertherm.com.

ITALIANO / ITALIAN

AVVERTENZA! Prima di usare un'attrezzatura Hypertherm, leggere le istruzioni sulla sicurezza nel manuale del prodotto e nel *Manuale sulla sicurezza e la conformità* (80669C). Il mancato rispetto delle istruzioni sulla sicurezza può causare lesioni personali o danni all'attrezzatura.

Il prodotto può essere accompagnato da copie elettroniche e cartacee del manuale. È anche possibile ottenere copie del manuale, in tutte le lingue disponibili per ogni manuale, dall'"Archivio documenti" all'indirizzo www.hypertherm.com.

NEDERLANDS / DUTCH

WAARSCHUWING! Lees voordat u Hypertherm-apparatuur gebruikt de veiligheidsinstructies in de producthandleiding en in de *Veiligheids- en nalevingshandleiding* (80669C). Het niet volgen van de veiligheidsinstructies kan resulteren in persoonlijk letsel of schade aan apparatuur.

De handleidingen kunnen in elektronische en gedrukte vorm met het product worden meegeleverd. De handleidingen, elke handleiding beschikbaar in alle talen, zijn ook verkrijgbaar via de "Documentenbibliotheek" op www.hypertherm.com.

DANSK / DANISH

ADVARSEL! Inden Hypertherm udstyr tages i brug skal sikkerhedsinstruktionerne i produktets manual og i *Manual om sikkerhed og overholdelse af krav* (80669C), gennelæses. Følges sikkerhedsvejledningen ikke kan det resultere i personskade eller beskadigelse af udstyret.

Kopier af manualerne kan ledsage produktet i elektroniske og trykte formater. Du kan også få kopier af manualer, på alle sprog der er til rådighed for hver manuel, fra "Dokumentbiblioteket" på www.hypertherm.com.

PORTUGUÊS / PORTUGUESE

AVERTÊNCIA! Antes de operar qualquer equipamento Hypertherm, leia as instruções de segurança no manual do seu produto e no *Manual de Segurança e de Conformidade* (80669C). Não seguir as instruções de segurança pode resultar em lesões corporais ou danos ao equipamento.

Cópias dos manuais podem acompanhar os produtos nos formatos eletrônico e impresso. Também é possível obter cópias dos manuais em todos os idiomas disponíveis para cada manual na "Biblioteca de documentos" em www.hypertherm.com.

日本語 / JAPANESE

警告! Hypertherm 機器を操作する前に、安全に関する重要な情報について、この製品説明書にある安全情報、および製品に同梱されている別冊の「安全とコンプライアンスマニュアル」(80669C)をお読みください。安全情報に従わないと怪我や装置の損傷を招くことがあります。

説明書のコピーは、電子フォーマット、または印刷物として製品に同梱されています。各説明書は、www.hypertherm.com の「ドキュメントライブラリ」から各言語で入手できます。

简体中文 / CHINESE (SIMPLIFIED)

警告! 在操作任何海宝设备之前, 请阅读产品手册和《安全法规遵守手册》(80669C) 中的安全操作说明。若未能遵循安全操作说明, 可能会造成人员受伤或设备损坏。

随产品提供的手册可能提供电子版和印刷版两种格式。您也可从 "Documents library" (文档资料库) 中获取每本手册所有可用语言的副本, 网址为 www.hypertherm.com。

NORSK / NORWEGIAN

ADVARSEL! Før du bruker noe Hypertherm-utstyr, må du lese sikkerhetsinstruksjonene i produktets håndbok og i *Håndboken om sikkerhet og samsvar* (80669C). Unnlattelse av å følge sikkerhetsinstruksjoner kan føre til personskade eller skade på utstyr.

Eksemplarer av håndbøkene kan medfølge produktet i elektroniske og trykte utgaver. Du kan også få eksemplarer av håndbøkene i alle tilgjengelige språk for hver håndbok fra dokumentbiblioteket på www.hypertherm.com.

SVENSKA / SWEDISH

VARNING! Läs häftet *säkerhetsinformationen i din produkts säkerhets- och efterlevnadsmanual* (80669C) för viktig säkerhetsinformation innan du använder eller underhåller Hypertherm-utrustning. Underlåtenhet att följa dessa säkerhetsinstruktioner kan resultera i personskador eller skador på utrustningen.

Kopior av manualen kan medfölja produkten i elektronisk och tryckform. Du hittar även kopior av manualerna i alla tillgängliga språk i dokumentbiblioteket (Documents library) på www.hypertherm.com.

한국어 / KOREAN

경고! Hypertherm 장비를 사용하기 전에 제품 설명서와 안전 및 규정 준수 설명서 (80669C)에 나와 있는 안전 지침을 읽으십시오. 안전 지침을 준수하지 않으면 신체 부상이나 장비 손상을 초래할 수 있습니다.

전자 형식과 인쇄된 형식으로 설명서 사본이 제품과 함께 제공될 수 있습니다. www.hypertherm.com 의 'Documents library (문서 라이브러리)' 에서도 모든 언어로 이용할 수 있는 설명서 사본을 얻을 수 있습니다.

ČESKY / CZECH

VAROVÁNÍ! Před uvedením jakéhokoliv zařízení Hypertherm do provozu si přečtěte bezpečnostní pokyny v příručce k produktu a v *Manuálu pro bezpečnost a dodržování předpisů* (80669C). Nedodržování bezpečnostních pokynů může mít za následek zranění osob nebo poškození majetku.

Kopie příruček a manuálů mohou být součástí dodávky produktu, a to v elektronické i tištěné formě. Kopie příruček a manuálů ve všech jazykových verzích, v nichž byly dané příručky a manuály vytvořeny, naleznete v „Knihovně dokumentů“ na webových stránkách www.hypertherm.com.

POLSKI / POLISH

OSTRZEŻENIE! Przed rozpoczęciem obsługi jakiegokolwiek systemu firmy Hypertherm należy się zapoznać z instrukcjami bezpieczeństwa zamieszczonymi w podręczniku produktu oraz w *Podręczniku bezpieczeństwa i zgodności* (80669C). Nieprzestrzeganie instrukcji bezpieczeństwa może skutkować obrażeniami ciała i uszkodzeniem sprzętu.

Do produktu mogą być dołączone kopie podręczników w formie elektronicznej i drukowanej. Kopie podręczników, w każdym udostępnionym języku, można również znaleźć w „Bibliotece dokumentów” pod adresem www.hypertherm.com.

РУССКИЙ / RUSSIAN

БЕРЕГИСЬ! Перед работой с любым оборудованием Hypertherm ознакомьтесь с инструкциями по безопасности, представленными в руководстве, которое поставляется вместе с продуктом, а также в *Руководстве по безопасности и соответствию* (80669J). Невыполнение инструкций по безопасности может привести к телесным повреждениям или повреждению оборудования.

Копии руководств, которые поставляются вместе с продуктом, могут быть представлены в электронном и бумажном виде. Копии руководств на всех языках, на которые переведено то или иное руководство, можно также загрузить в разделе «Библиотека документов» на веб-сайте www.hypertherm.com.

SUOMI / FINNISH

VAROITUS! Ennen minkään Hypertherm-laitteen käyttöä lue tuotteen käyttöoppaassa olevat turvallisuusohjeet ja *turvallisuus- ja vaatimustenmukaisuusohje* (80669C). Turvallisuusohjeiden laiminlyönti voi aiheuttaa henkilökohtaisen loukkaantumisen tai laitevahingon.

Käyttöoppaiden kopiot voivat olla tuotteen mukana elektronisessa ja tulostetussa muodossa. Voit saada käyttöoppaiden kopiot kaikilla kielillä ”latauskirjastosta”, joka on osoitteessa www.hypertherm.com.

БЪЛГАРСКИ / BULGARIAN

ПРЕДУПРЕЖДЕНИЕ! Преди да работите с което и да е оборудване Hypertherm, прочетете инструкциите за безопасност в ръководството на вашия продукт и „Инструкция за безопасност и съответствие“ (80669C). Неспазването на инструкциите за безопасност би могло да доведе до телесно нараняване или до повреда на оборудването.

Копия на ръководствата може да придружават продукта в електронен и в печатен формат. Можете да получите копия на ръководствата, предлагани на всички езици, от „Documents library“ (Библиотека за документи) на адрес www.hypertherm.com.

ROMÂNĂ / ROMANIAN

AVERTIZARE! Înainte de utilizarea oricărui echipament Hypertherm, citiți instrucțiunile de siguranță din cadrul manualului produsului și din cadrul *Manualului de siguranță și conformitate* (80669C). Nerespectarea instrucțiilor de siguranță pot rezulta în vătămare personală sau în avarierea echipamentului.

Produsul poate fi însoțit de copii ale manualului în format tipărit și electronic. De asemenea, dumneavoastră puteți obține copii ale manualelor, în toate limbile disponibile pentru fiecare manual, din cadrul secțiunii „Biblioteca documente” afiată pe site-ul www.hypertherm.com.

TÜRKÇE / TURKISH

UYARI! Bir Hypertherm ekipmanını çalıştırmadan önce, ürün kullanım kılavuzunda ve *Güvenlik ve Uyumluluk Kılavuzu'nda* (80669C) yer alan güvenlik talimatlarını okuyun. Güvenlik talimatlarına uyulmaması durumunda kişisel yaralanmalar veya ekipman hasarı meydana gelebilir.

Kılavuzların kopyaları, elektronik ve basılı formatta ürünle birlikte verilebilir. Her biri tüm dillerde yayınlanan kılavuzların kopyalarını www.hypertherm.com adresindeki “Documents library” (Dosyalar kitaplığı) başlığından da elde edebilirsiniz.

MAGYAR / HUNGARIAN

VIGYÁZAT! Mielőtt bármilyen Hypertherm berendezést üzemeltetne, olvassa el a biztonsági információkat a termék kézikönyvében és a *Biztonsági és szabálykövetési kézikönyvben* (80669C). A biztonsági utasítások betartásának elmulasztása személyi sérüléshez vagy a berendezés károsodásához vezethet.

A termékhez a kézikönyv példányai elektronikus és nyomtatott formában is mellékelve lehetnek. A kézikönyvek példányai (minden nyelven) a www.hypertherm.com weboldalon a „Documents library” (Dokumentum könyvtár) részben is beszerezhető.

ΕΛΛΗΝΙΚΑ / GREEK

ΠΡΟΕΙΔΟΠΟΙΗΣΗ! Πριν θέσετε σε λειτουργία οποιοδήποτε εξοπλισμό της Hypertherm, διαβάστε τις οδηγίες ασφαλείας στο εγχειρίδιο του προϊόντος και στο *Εγχειρίδιο ασφαλείας και συμμόρφωσης* (80669C). Η μη τήρηση των οδηγιών ασφαλείας μπορεί να επιφέρει σωματική βλάβη ή ζημία στον εξοπλισμό.

Αντίγραφα των εγχειριδίων μπορεί να συνοδεύουν το προϊόν σε ηλεκτρονική και έντυπη μορφή. Μπορείτε, επίσης, να λάβετε αντίγραφα των εγχειριδίων σε όλες τις γλώσσες που διατίθενται για κάθε εγχειρίδιο από την ψηφιακή βιβλιοθήκη εγγράφων (Documents library) στη διαδικτυακή τοποθεσία www.hypertherm.com.

繁體中文 / CHINESE (TRADITIONAL)

警告！在操作任何 Hypertherm 設備前，請閱讀您產品手冊和《安全和法務遵從手冊》(80669C) 內的安全指示。不遵守安全指示可能會導致人身傷害或設備損壞。

手冊複本可能以電子和印刷格式隨附產品提供。您也可以從 www.hypertherm.com 的「文檔資料庫」內獲取所有手冊的多語種複本。

SLOVENŠČINA / SLOVENIAN

OPOZORILO! Pred uporabo katerekoli Hyperthermove opreme preberite varnostna navodila v priročniku vašega izdelka ter v *Priročniku za varnost in skladnost* (80669C). Neupoštevanje navodil za uporabo lahko povzroči telesne poškodbe ali materialno škodo.

Izdelku so lahko priloženi izvodi priročnikov v elektronski ali tiskani obliki. Izvode priročnikov v vseh razpoložljivih jezikih si lahko prenesete tudi iz knjižnice dokumentov “Documents library” na naslovu www.hypertherm.com.

SRPSKI / SERBIAN

UPOZORENJE! Pre rukovanja bilo kojom Hyperthermovom opremom pročitajte uputstva o bezbednosti u svom priručniku za proizvod i u *Priručniku o bezbednosti i usaglašenosti* (80669C). Oglašavanje o praćenje uputstava o bezbednosti može da ima za posledicu ličnu povredu ili oštećenje opreme.

Može se dogoditi da kopije priručnika prate proizvod u elektronskom i štampanom formatu. Takođe možete da pronađete kopije priručnika, na svim jezicima koji su dostupni za svaki od priručnika, u “Biblioteci dokumenata” (“Documents library”) na www.hypertherm.com.

SLOVENČINA / SLOVAK

VÝSTRAHA! Pred použitím akéhokoľvek zariadenia od spoločnosti Hypertherm si prečítajte bezpečnostné pokyny v návode na obsluhu vášho zariadenia a v *Manuáli o bezpečnosti a súlade s normami* (80669C). V prípade nedodržania bezpečnostných pokynov môže dôjsť k ujme na zdraví alebo poškodeniu zariadenia.

Kópia návodu, ktorá je dodávaná s produktom, môže mať elektronickú alebo tlačенú podobu. Kópie návodov, vo všetkých dostupných jazykoch, sú k dispozícii aj v sekcii z „knihnice Dokumenty“ na www.hypertherm.com.

Electromagnetic Compatibility (EMC)	SC-11
Introduction	SC-11
Installation and use	SC-11
Assessment of area	SC-11
Methods of reducing emissions	SC-11
Mains supply	SC-11
Maintenance of cutting equipment	SC-11
Cutting cables	SC-11
Equipotential bonding	SC-11
Earthing of the workpiece	SC-12
Screening and shielding	SC-12
Warranty	SC-13
Attention	SC-13
General	SC-13
Patent indemnity	SC-13
Limitation of liability	SC-13
National and local codes	SC-13
Liability cap	SC-14
Insurance	SC-14
Transfer of rights	SC-14
Waterjet product warranty coverage	SC-14
Product	SC-14
Parts coverage	SC-14

1	Specifications	15
	Safety information	15
	Powermax125 System description	15
	Power supply dimensions	16
	Component weights (125 A systems)	17
	Hypertherm power supply ratings	18
	Duramax Hyamp 85° hand torch dimensions	19
	Duramax Hyamp 15° hand torch dimensions	19
	Duramax Hyamp 180° full-length machine torch dimensions	20
	Duramax Hyamp 180° mini machine torch dimensions	20
	Powermax125 cutting specifications	21
	Symbols and marks	22
	Noise levels	23
	IEC symbols	24
2	Power Supply Setup	25
	Unpack the Powermax system	25
	Claims	25
	Contents	26
	Position the power supply	26
	Prepare the electrical power	27
	Install a line-disconnect switch	27
	Requirements for grounding	27
	Power connection for the Powermax125	28
	Three-phase power cord and plug installation	29
	Decrease output current for lower-rated power plugs	29
	Extension cord recommendations	31
	Engine-driven generator recommendations	31
	Prepare the gas supply	32
	Additional gas filtration	32
	Connect the gas supply	33
	Minimum inlet pressure (while gas is flowing)	34
	Gas flow rates	34
3	Basic System Operations	35
	Controls and indicators	35
	Rear controls	35
	Front controls and LEDs	36
	LEDs	36
	Selectors	36
	Operating mode switch	37

- Amperage adjustment knob 37
- Status screen 37
 - Gas pressure indicators 38
 - System status icons 38
 - Fault codes and icons 38
- Operating the Powermax 40
 - Connect the electrical power, gas supply, and torch lead 40
 - Attach the work lead to the power supply 41
 - Attach the ground clamp to the workpiece 42
 - Turn on the system 42
 - Set the operating mode switch 43
 - Check the indicators 43
 - Manually adjusting the gas pressure 44
 - Adjusting the current (amperage) 44
- Electrode end-of-life detection feature 45
- Understanding duty-cycle limitations 46

- 4 Hand Torch Setup 47**
 - Introduction 47
 - Consumable life 47
 - Hand torch components 48
 - Duramax Hyamp 85° hand torch 48
 - Duramax Hyamp 15° hand torch 48
 - Choose the hand torch consumables 48
 - Drag-cutting 105/125 A consumables 49
 - Drag-cutting 45 A and 65 A consumables 49
 - Gouging consumables 49
 - FineCut consumables 49
 - Install the hand torch consumables 50
 - Connecting the torch lead 51

- 5 Hand Cutting 53**
 - Using the hand torch 53
 - Operate the safety trigger 54
 - Hand torch cutting guidelines 54
 - Start a cut from the edge of the workpiece 55
 - Pierce a workpiece 56
 - Gouge a workpiece 58
 - Varying the gouge profile 60
 - 125 A gouging profile chart 60
 - Common hand-cutting faults 62

6 Machine Torch Setup	63
Introduction	63
Consumable life	63
Machine torch components	64
Duramax Hyamp 180° machine torch	64
Duramax Hyamp 180° mini machine torch	64
Disassemble the machine torch	65
Convert a full-length machine torch to a mini machine torch	67
Mount the torch	68
Choose the machine torch consumables	69
Machine torch consumables	69
Mechanized shielded 105 A/125 A consumables	69
Mechanized shielded 45 A and 65 A consumables	69
Mechanized shielded with ohmic 105 A/125 A consumables	70
Mechanized shielded with ohmic 45 A and 65 A consumables	70
Gouging consumables	70
FineCut shielded consumables	70
FineCut shielded with ohmic consumables	71
Install the machine torch consumables	71
Aligning the torch	71
Connecting the torch lead	72
Using the cut charts	73
Estimated kerf-width compensation	74
Estimated kerf-width compensation – Metric (mm)	74
Estimated kerf-width compensation – English (inches)	75
125 A shielded consumables	76
125 A shielded cutting – mild steel	77
125 A shielded cutting – stainless steel	78
125 A shielded cutting – aluminum	79
105 A shielded consumables	80
105 A shielded cutting – mild steel	81
105 A shielded cutting – stainless steel	82
105 A shielded cutting – aluminum	83
65 A shielded consumables	84
65 A shielded cutting – mild steel	85
65 A shielded cutting – stainless steel	86
65 A shielded cutting – aluminum	87
45 A shielded consumables	88
45 A shielded cutting – mild steel	89
45 A shielded cutting – stainless steel	90
45 A shielded cutting – aluminum	91

FineCut consumables	92
FineCut – mild steel	93
FineCut – stainless steel	94
7 Mechanized Cutting	95
Connecting an optional remote-start pendant	95
Connecting the machine interface cable	96
Machine interface pinout	98
Setting the five-position voltage divider	99
Accessing raw arc voltage	100
Connecting an optional RS-485 serial interface cable	100
Serial port cables	101
Using the machine torch	101
Setting up the torch and table	101
Understand and optimize cut quality	101
Cut or bevel angle	102
Dross	102
Piercing a workpiece using the machine torch	103
Common machine-cutting faults	103
8 Maintenance and Repair	105
Perform routine maintenance	105
Routine maintenance tasks	106
Inspect the Powermax125 consumables	107
Basic troubleshooting	108
Troubleshooting guide	108
Fault codes and solutions	109
Fault codes	109
Display the service screen	112
Run a gas test	113
Replace the air filter element and air filter bowl	114
Remove the air filter bowl	114
Identify air filter bowl model	115
Install the air filter element (for plastic or nylon bowl)	115
Install the air filter element (for metal guarded bowl)	117
Install the air filter bowl (metal guarded, plastic, or nylon)	118

- 9 Parts 119**
- Power supply parts 120
 - Exterior, front 120
 - Exterior, rear 121
 - Interior, fan side 123
- Duramax Hyamp 85° hand torch replacement parts 124
- Duramax Hyamp 15° hand torch replacement parts 125
- Hand torch consumables 126
 - Drag cutting 126
 - Gouging 126
 - FineCut 126
- Duramax Hyamp 180° full-length machine torch replacement parts 127
- Duramax Hyamp 180° mini machine torch replacement parts 128
- Machine torch consumables 129
 - Shielded 129
 - Gouging 129
 - FineCut 130
- Accessory parts 130
- Powermax125 labels 131

Introduction

Hypertherm's CE-marked equipment is built in compliance with standard EN60974-10. The equipment should be installed and used in accordance with the information below to achieve electromagnetic compatibility.

The limits required by EN60974-10 may not be adequate to completely eliminate interference when the affected equipment is in close proximity or has a high degree of sensitivity. In such cases it may be necessary to use other measures to further reduce interference.

This cutting equipment is designed for use only in an industrial environment.

Installation and use

The user is responsible for installing and using the plasma equipment according to the manufacturer's instructions.

If electromagnetic disturbances are detected then it shall be the responsibility of the user to resolve the situation with the technical assistance of the manufacturer. In some cases this remedial action may be as simple as earthing the cutting circuit, see *Earthing of the workpiece*. In other cases, it could involve constructing an electromagnetic screen enclosing the power source and the work complete with associated input filters. In all cases, electromagnetic disturbances must be reduced to the point where they are no longer troublesome.

Assessment of area

Before installing the equipment, the user shall make an assessment of potential electromagnetic problems in the surrounding area. The following shall be taken into account:

- a. Other supply cables, control cables, signaling and telephone cables; above, below and adjacent to the cutting equipment.
- b. Radio and television transmitters and receivers.
- c. Computer and other control equipment.
- d. Safety critical equipment, for example guarding of industrial equipment.
- e. Health of the people around, for example the use of pacemakers and hearing aids.
- f. Equipment used for calibration or measurement.
- g. Immunity of other equipment in the environment. User shall ensure that other equipment being used in the environment is compatible. This may require additional protection measures.
- h. Time of day that cutting or other activities are to be carried out.

The size of the surrounding area to be considered will depend on the structure of the building and other activities that are taking place. The surrounding area may extend beyond the boundaries of the premises.

Methods of reducing emissions

Mains supply

Cutting equipment must be connected to the mains supply according to the manufacturer's recommendations. If interference occurs, it may be necessary to take additional precautions such as filtering of the mains supply.

Consideration should be given to shielding the supply cable of permanently installed cutting equipment, in metallic conduit or equivalent. Shielding should be electrically continuous throughout its length. The shielding should be connected to the cutting mains supply so that good electrical contact is maintained between the conduit and the cutting power source enclosure.

Maintenance of cutting equipment

The cutting equipment must be routinely maintained according to the manufacturer's recommendations. All access and service doors and covers should be closed and properly fastened when the cutting equipment is in operation. The cutting equipment should not be modified in any way, except as set forth in and in accordance with the manufacturer's written instructions. For example, the spark gaps of arc striking and stabilizing devices should be adjusted and maintained according to the manufacturer's recommendations.

Cutting cables

The cutting cables should be kept as short as possible and should be positioned close together, running at or close to the floor level.

Equipotential bonding

Bonding of all metallic components in the cutting installation and adjacent to it should be considered.

However, metallic components bonded to the workpiece will increase the risk that the operator could receive a shock by touching these metallic components and the electrode (nozzle for laser heads) at the same time.

The operator should be insulated from all such bonded metallic components.

Electromagnetic Compatibility (EMC)

Earthing of the workpiece

Where the workpiece is not bonded to earth for electrical safety, nor connected to earth because of its size and position, for example, ship's hull or building steel work, a connection bonding the workpiece to earth may reduce emissions in some, but not all instances. Care should be taken to prevent the earthing of the workpiece increasing the risk of injury to users, or damage to other electrical equipment. Where necessary, the connection of the workpiece to earth should be made by a direct connection to the workpiece, but in some countries where direct connection is not permitted, the bonding should be achieved by suitable capacitances selected according to national regulations.

Note: The cutting circuit may or may not be earthed for safety reasons. Changing the earthing arrangements should only be authorized by a person who is competent to assess whether the changes will increase the risk of injury, for example, by allowing parallel cutting current return paths which may damage the earth circuits of other equipment. Further guidance is provided in IEC 60974-9, Arc Welding Equipment, Part 9: Installation and Use.

Screening and shielding

Selective screening and shielding of other cables and equipment in the surrounding area may alleviate problems of interference. Screening of the entire plasma cutting installation may be considered for special applications.

Attention

Genuine Hypertherm parts are the factory-recommended replacement parts for your Hypertherm system. Any damage or injury caused by the use of other than genuine Hypertherm parts may not be covered by the Hypertherm warranty, and will constitute misuse of the Hypertherm Product.

You are solely responsible for the safe use of the Product. Hypertherm does not and cannot make any guarantee or warranty regarding the safe use of the product in your environment.

General

Hypertherm Inc. warrants that its Products shall be free from defects in materials and workmanship for the specific periods of time set forth herein and as follows: if Hypertherm is notified of a defect (i) with respect to the plasma power supply within a period of two (2) years from the date of its delivery to you, with the exception of Powermax brand power supplies, which shall be within a period of three (3) years from the date of delivery to you, and (ii) with respect to the torch and leads within a period of one (1) year from its date of delivery to you, with the exception of the HPRXD short torch with integrated lead, which shall be within a period of six (6) months from the date of delivery to you, and with respect to torch lifter assemblies within a period of one (1) year from its date of delivery to you, and with respect to Automation products one (1) year from its date of delivery to you, with the exception of the EDGE Connect CNC, EDGE Connect T CNC, EDGE Connect TC CNC, EDGE Pro CNC, EDGE Pro Ti CNC, MicroEDGE Pro CNC, and ArcGlide THC, which shall be within a period of two (2) years from the date of delivery to you, and (iii) with respect to HyIntensity fiber laser components within a period of two (2) years from the date of its delivery to you, with the exception of laser heads and beam delivery cables, which shall be within a period of one (1) year from its date of delivery to you.

This warranty shall not apply to any Powermax brand power supplies that have been used with phase converters. In addition, Hypertherm does not warranty systems that have been damaged as a result of poor power quality, whether from phase converters or incoming line power. This warranty shall not apply to any product which has been incorrectly installed, modified, or otherwise damaged.

Hypertherm provides repair, replacement or adjustment of the Product as the sole and exclusive remedy, if and only if the warranty set forth herein properly is invoked and applies. Hypertherm, at its sole option, shall repair, replace, or adjust, free of charge, any defective Products covered by this warranty which shall be returned with Hypertherm's prior authorization (which shall not be unreasonably withheld), properly packed, to Hypertherm's place of business in Hanover, New Hampshire, or to an authorized Hypertherm repair facility, all costs, insurance and freight pre paid by the customer. Hypertherm shall not be liable for any repairs, replacement, or adjustments of Products covered by this warranty, except those made pursuant to this paragraph and with Hypertherm's prior written consent.

The warranty set forth above is exclusive and is in lieu of all other warranties, express, implied, statutory, or otherwise with respect to the Products or as to the results which may be obtained therefrom, and all implied warranties or conditions of quality or of merchantability or fitness for a particular purpose or against infringement. The foregoing shall constitute the sole and exclusive remedy for any breach by Hypertherm of its warranty.

Distributors/OEMs may offer different or additional warranties, but Distributors/OEMs are not authorized to give any additional warranty protection to you or make any representation to you purporting to be binding upon Hypertherm.

Patent indemnity

Except only in cases of products not manufactured by Hypertherm or manufactured by a person other than Hypertherm not in strict conformity with Hypertherm's specifications and in cases of designs, processes, formulae, or combinations not developed or purported to be developed by Hypertherm, Hypertherm will have the right to defend or settle, at its own expense, any suit or proceeding brought against you alleging that the use of the Hypertherm product, alone and not in combination with any other product not supplied by Hypertherm, infringes any patent of any third party. You shall notify Hypertherm promptly upon learning of any action or threatened action in connection with any such alleged infringement (and in any event no longer than fourteen (14) days after learning of any action or threat of action), and Hypertherm's obligation to defend shall be conditioned upon Hypertherm's sole control of, and the indemnified party's cooperation and assistance in, the defense of the claim.

Limitation of liability

In no event shall Hypertherm be liable to any person or entity for any incidental, consequential direct, indirect, punitive or exemplary damages (including but not limited to lost profits) regardless of whether such liability is based on breach of contract, tort, strict liability, breach of warranty, failure of essential purpose, or otherwise, and even if advised of the possibility of such damages. Hypertherm shall not be liable for any losses to Distributor based on down time, lost production or lost profits. It is the intention of the Distributor and Hypertherm that this provision be construed by a court as being the broadest limitation of liability consistent with applicable law.

National and local codes

National and local codes governing plumbing and electrical installation shall take precedence over any instructions contained in this manual. In no event shall Hypertherm be liable for injury to persons or property damage by reason of any code violation or poor work practices.

Warranty

Liability cap

In no event shall Hypertherm's liability, if any, whether such liability is based on breach of contract, tort, strict liability, breach of warranties, failure of essential purpose or otherwise, for any claim, action, suit or proceeding (whether in court, arbitration, regulatory proceeding or otherwise) arising out of or relating to the use of the Products exceed in the aggregate the amount paid for the Products that gave rise to such claim.

Insurance

At all times you will have and maintain insurance in such quantities and types, and with coverage sufficient and appropriate to defend and to hold Hypertherm harmless in the event of any cause of action arising from the use of the products.

Transfer of rights

You may transfer any remaining rights you may have hereunder only in connection with the sale of all or substantially all of your assets or capital stock to a successor in interest who agrees to be bound by all of the terms and conditions of this Warranty. Within thirty (30) days before any such transfer occurs, you agree to notify in writing Hypertherm, which reserves the right of approval. Should you fail timely to notify Hypertherm and seek its approval as set forth herein, the Warranty set forth herein shall be null and void and you will have no further recourse against Hypertherm under the Warranty or otherwise.

Waterjet product warranty coverage

Product	Parts coverage
HyPrecision pumps	27 months from the ship date, or 24 months from the date of proven installation, or 4,000 hours, whichever occurs first
PowerDredge abrasive removal system	15 months from the ship date or 12 months from the date of proven installation, whichever occurs first
EcoSift abrasive recycling system	15 months from the ship date or 12 months from the date of proven installation, whichever occurs first
Abrasive metering devices	15 months from the ship date or 12 months from the date of proven installation, whichever occurs first
On/off valve air actuators	15 months from the ship date or 12 months from the date of proven installation, whichever occurs first
Diamond orifices	600 hours of use with the use of a thimble filter and compliance with Hypertherm's water quality requirements

Consumable parts are not covered by this warranty. Consumable parts include, but are not limited to, high-pressure water seals, check valves, cylinders, bleed-down valves, low-pressure seals, high-pressure tubing, low- and high-pressure water filters and abrasive collection bags. All third-party pumps, pump accessories, hoppers, hopper accessories, dryer boxes, dryer box accessories and plumbing accessories are covered by the respective manufacturers' warranties and not covered by this warranty.

Safety information

Before operating any Hypertherm equipment, read the separate *Safety and Compliance Manual* (80669C) included with your product for important safety information.

Powermax125 System description

The Powermax125 is a highly portable, 125 A, handheld and mechanized plasma cutting system appropriate for a wide range of applications. The Powermax system uses air or nitrogen to cut electrically conductive metals, such as mild steel, stainless steel, or aluminum. Smart Sense™ technology automatically adjusts the gas pressure according to cutting mode and torch lead length for optimum cutting.

The Powermax125 is recommended for metal thicknesses up to 44 mm (1-3/4 inches), can sever up to 57 mm (2-1/4 inches), and can pierce thicknesses up to 25 mm (1 inch). FastConnect™ provides a simple push-button torch connection to the power supply for quick torch changes.

The typical handheld Powermax125 system includes a Duramax™ Hyamp 85° hand torch *with* a starter consumable kit, a box of spare electrodes and nozzles, and a work lead cable. Reference materials include: operator manual, quick setup card, registration card, setup DVD, and safety manual.

The typical mechanized Powermax125 system includes a Duramax Hyamp 180° full-length machine torch with a starter consumable kit, a box of spare electrodes and nozzles, work lead cable, and remote-start pendant. Reference materials include: operator manual, quick setup card, registration card, setup DVD, and safety manual.

See your Hypertherm distributor for other system configurations. You can order additional styles of torches, consumables, and accessories, such as the plasma cutting guide. See *Parts* on page 119 for a list of spare and optional parts.

Powermax125 CSA and CE power supplies ship without a plug on the power cord. See *Power Supply Setup* on page 25.



CCC certified configurations do not ship with a power cord.

1 – Specifications

Powermax125 3-phase systems include the following models:

- 480 V CSA (480 V only)
- 600 V CSA (600 V only)
- 400 V CE (400 V only)
- 380 V CCC (380 V only)



To maintain CE certification, install power cord kit 228886.

Power supply dimensions

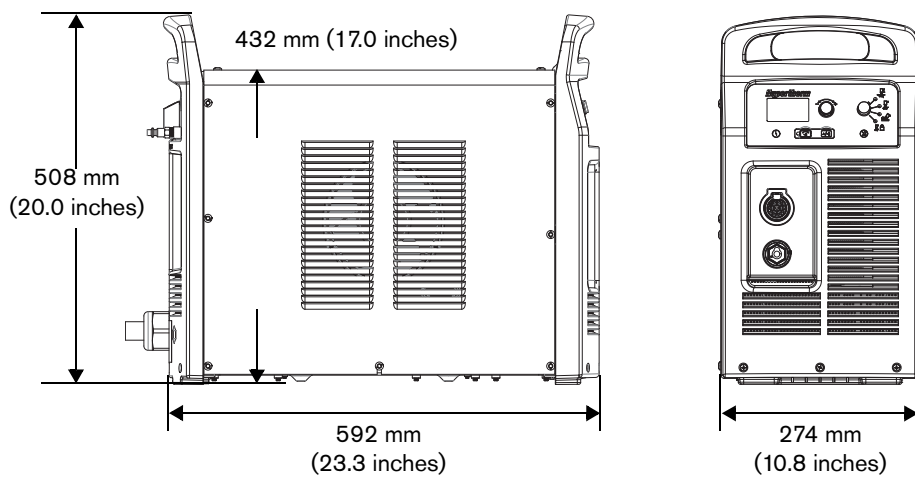

Component weights (125 A systems)

Table 1 – Power supply weights

Voltage	480 V CSA	600 V CSA	400 V CE	380 V CCC (no power cord)
Power supply	41 kg (90 pounds)	40 kg (89 pounds)	42 kg (92 pounds)	38 kg (84 pounds)
With 7.6 m (25 foot) hand torch and 7.6 m (25 foot) work lead	48 kg (106 pounds)	48 kg (105 pounds)	49 kg (108 pounds)	45 kg (100 pounds)

Table 2 – Torch weights

Hand torch 7.6 m (25 feet)	3.5 kg (7.7 pounds)
Hand torch 15 m (50 feet)	6.2 kg (13.7 pounds)
Hand torch 23 m (75 feet)	8.8 kg (19.5 pounds)
Machine torch 7.6 m (25 feet)	3.7 kg (8.2 pounds)
Machine torch 11 m (35 feet)	4.8 kg (10.6 pounds)
Machine torch 15 m (50 feet)	6.4 kg (14.2 pounds)
Machine torch 23 m (75 feet)	9.2 kg (20.3 pounds)

Table 3 – Work lead weights

Work lead 7.6 m (25 feet)	3.6 kg (8 pounds)
Work lead 15 m (50 feet)	6.6 kg (14.6 pounds)
Work lead 23 m (75 feet)	9.6 kg (21.2 pounds)

Hypertherm power supply ratings

Rated open-circuit voltage (U_0)	480/600 V CSA 400 V CE 380 V CCC	320 VDC 305 VDC 290 VDC
Output characteristic*	Drooping	
Rated output current (I_2)	30 – 125 A	
Rated output voltage (U_2)	175 VDC	
Duty cycle at 40° C (104° F)	480/600 V CSA 400 V CE 380 V CCC	100% at 125 A, 480/600 V, 3-PH 100% at 125 A, 400 V, 3-PH 100% at 125 A, 380 V, 3-PH
Operating temperature	-10° to 40° C (14° to 104° F)	
Storage temperature	-25° to 55° C (-13° to 131° F)	
Power factor	0.94	
$R_{s_{ce}}$ – Short Circuit Ratio (CE models only)	U_1 – Volts AC rms, 3-PH	$R_{s_{ce}}$
	400 V CE	250
EMC emissions classification CISPR 11 (CE models only)**	Class A	
Input voltage (U_1)/ Input current (I_1) at rated output ($U_{2\text{MAX}}$ $I_{2\text{MAX}}$) (See <i>Power Supply Setup</i> on page 25.)	480/600 V CSA	480/600 V, 3-PH, 50/60 Hz, 31/24 A
	400 V CE†‡	400 V, 3-PH, 50/60 Hz, 36 A
	380 V CC	380 V, 3-PH, 50/60 Hz, 38 A
Gas type	Air	Nitrogen
Gas quality	Clean, dry, oil-free per ISO 8573-1 Class 1.2.2	99.95% pure
Recommended gas inlet flow rate/pressure	Cutting: 260 slpm (550 scfh, 9.2 scfm) at: <ul style="list-style-type: none"> ▪ 5.9 bar (85 psi) for 7.6 m (25 foot) and 15 m (50 foot) torches ▪ 6.6 bar (95 psi) for 23 m (75 foot) torches Gouging: 212 slpm (450 scfh, 7.5 scfm) at 4.1 bar (60 psi)	

* Defined as a plot of output voltage versus output current.

** This Class A equipment is not intended for use in residential locations where the electrical power is provided by the public low-voltage supply system. There may be potential difficulties in ensuring electromagnetic compatibility in those locations due to conducted or radiated disturbances.

† This product meets the technical requirements of IEC 61000-3-3 and is not subject to conditional connection.

‡ Equipment complies with IEC 61000-3-12 provided that the short-circuit power S_{sc} is greater than or equal to 5363 KVA at the interface point between the user's supply and the public system. It is the responsibility of the installer or user of the equipment to ensure, by consultation with the distribution network operator if necessary, that the equipment is connected only to a supply with a short-circuit power S_{sc} greater than or equal to 5363 KVA.

Duramax Hyamp 85° hand torch dimensions

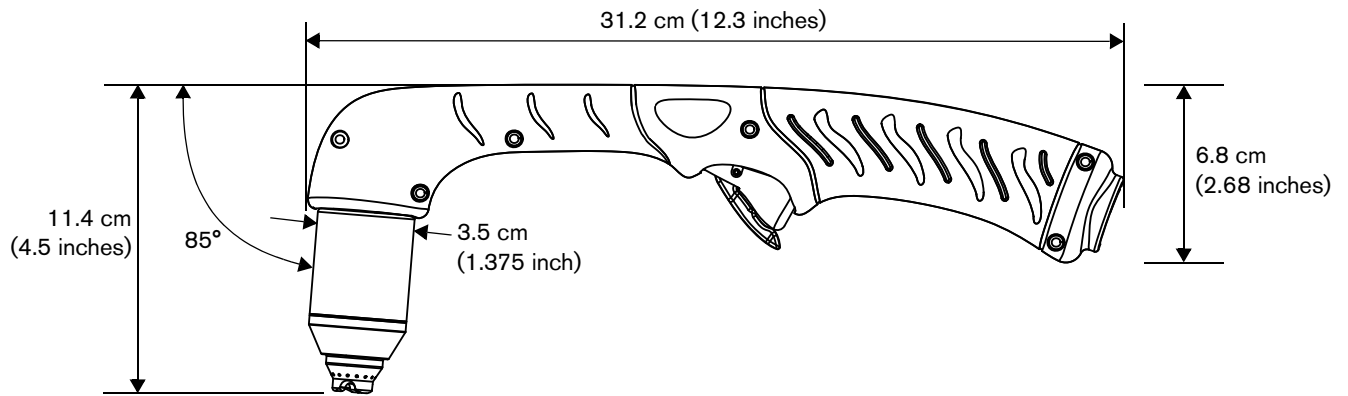

Duramax Hyamp 15° hand torch dimensions

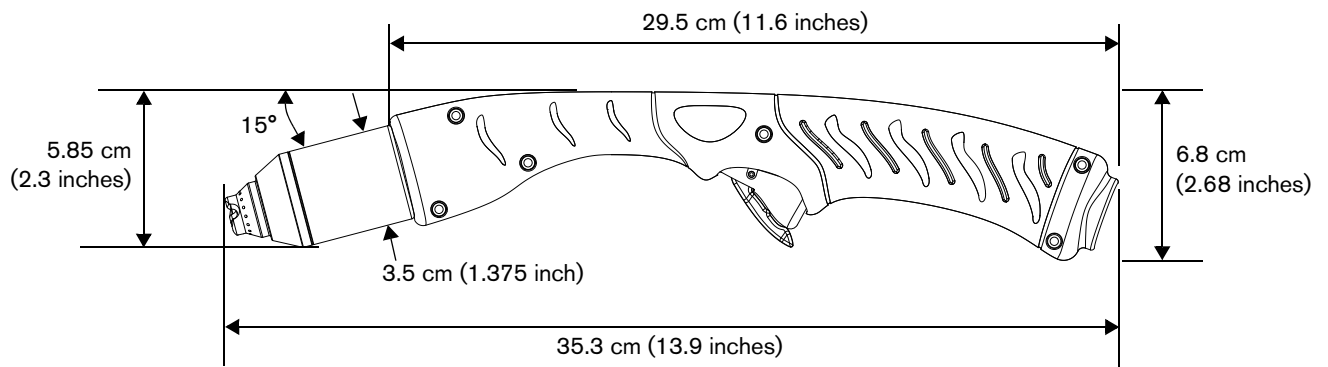

Duramax Hyamp 180° full-length machine torch dimensions

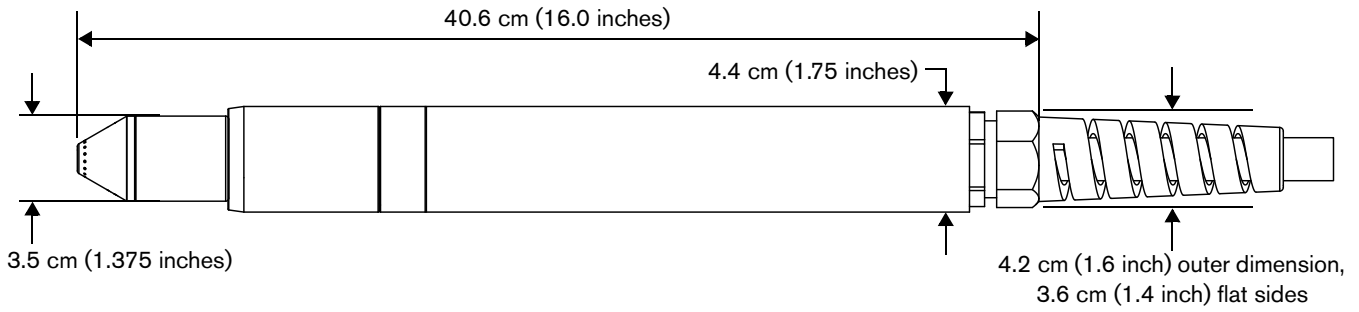

Duramax Hyamp 180° mini machine torch dimensions

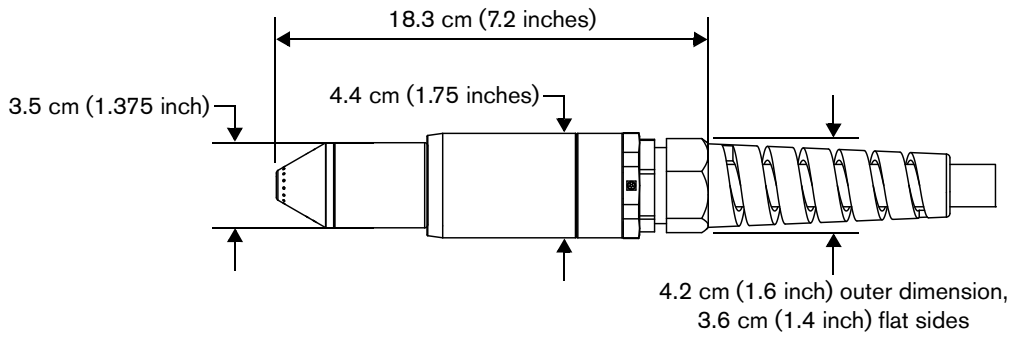

Powermax125 cutting specifications

Handheld cut capacity (material thickness)	
Recommended cut capacity at 457 mm/min (18 ipm)*	38 mm (1-1/2 inches)
Recommended cut capacity at 250 mm/min (10 ipm)*	44 mm (1-3/4 inches)
Severance capacity at 125 mm/min (5 ipm)*	57 mm (2-1/4 inches)
Pierce capacity (material thickness)	
Pierce capacity for handheld cutting, or mechanized cutting with programmable torch height control	25 mm (1 inch)
Pierce capacity for mechanized cutting without programmable torch height control	22 mm (7/8 inch)
Maximum cut speed** (mild steel)	
6 mm (1/4 inch)	7160 mm/min (282 ipm)
10 mm (3/8 inch)	4390 mm/min (173 ipm)
12 mm (1/2 inch)	2950 mm/min (116 ipm)
16 mm (5/8 inch)	2110 mm/min (83 ipm)
20 mm (3/4 inch)	1470 mm/min (58 ipm)
22 mm (7/8 inch)	1170 mm/min (46 ipm)
25 mm (1 inch)	940 mm/min (37 ipm)
32 mm (1-1/4 inches)	610 mm/min (24 ipm)
38 mm (1-1/2 inches)	457 mm/min (18 ipm)
Gouging capacity	
Metal removal rate on mild steel (125 A)	12.5 kg/hour (27 pounds/hour)
Duramax Hyamp series torch weights (refer to <i>Component weights (125 A systems)</i> on page 17)	
Duty cycle and voltage information (refer to <i>Hypertherm power supply ratings</i> on page 18)	

* Cut capacity speeds are not necessarily maximum speeds. They are the speeds that must be achieved to be rated at that thickness.

** Maximum cut speeds are the results of Hypertherm's laboratory testing. Actual cutting speeds may vary based on different cutting applications.

Symbols and marks

Your product may have one or more of the following markings on or near the data plate. Due to differences and conflicts in national regulations, not all marks are applied to every version of a product.



S mark

The S mark indicates that the power supply and torch are suitable for operations carried out in environments with increased hazard of electrical shock according to IEC 60974-1.



CSA mark

Products with a CSA mark meet the United States and Canadian regulations for product safety. The products were evaluated, tested, and certified by CSA-International. Alternatively, the product may have a mark by one of the other Nationally Recognized Testing Laboratories (NRTL) accredited in both the United States and Canada, such as UL or TÜV.



CE mark

The CE marking signifies the manufacturer's declaration of conformity to applicable European directives and standards. Only those versions of products with a CE marking located on or near the data plate have been tested for compliance with the European Low Voltage Directive and the European Electromagnetic Compatibility (EMC) Directive. EMC filters needed to comply with the European EMC Directive are incorporated within versions of the product with a CE marking.



Eurasian Customs Union (CU) mark

CE versions of products that include an EAC mark of conformity meet the product safety and EMC requirements for export to Russia, Belarus, and Kazakhstan.



GOST-TR mark

CE versions of products that include a GOST-TR mark of conformity meet the product safety and EMC requirements for export to the Russian Federation.



N30932

C-Tick mark

CE versions of products with a C-Tick mark comply with the EMC regulations required for sale in Australia and New Zealand.



CCC mark

The China Compulsory Certification (CCC) mark indicates that the product has been tested and found compliant with product safety regulations required for sale in China.



UkrSEPRO mark

The CE versions of products that include a UkrSEPRO mark of conformity meet the product safety and EMC requirements for export to the Ukraine.



Serbian AAA mark

CE versions of products that include a AAA Serbian mark meet the product safety and EMC requirements for export to Serbia.

Noise levels

This plasma system may exceed acceptable noise levels as defined by national and local codes. Always wear proper ear protection when cutting or gouging. Any noise measurements taken depend on the specific environment in which the system is used. Refer to *Noise can damage hearing* in the *Safety and Compliance Manual (80669C)* included with your system.















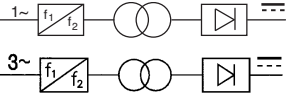
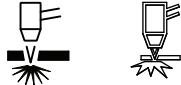

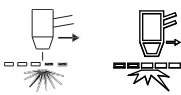
In addition, you can find an *Acoustical Noise Data Sheet* for your system in the Hypertherm downloads library at <https://www.hypertherm.com>:

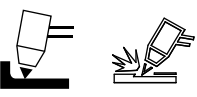
1. Click “Documents library.”
2. Select a product from the “Product type” menu.
3. Select “Regulatory” from the “Category” menu.
4. Select “Acoustical Noise Data Sheets” from the “Sub Category” menu.

1 – Specifications

IEC symbols

The following symbols may appear on the power supply data plate, control labels, switches, LEDs, and LCD screen.

	Direct current (DC)		Power is ON
	Alternating current (AC)		Power is OFF
	Plasma torch cutting		An inverter-based power source, either 1-phase or 3-phase
	Plate metal cutting		Volt/amperage curve, "drooping" characteristic
	Expanded metal cutting		Power is ON (LED)
	Gouging		System fault (LED)
	Torch lock		Inlet gas pressure fault (LCD)
	AC input power connection		Missing or loose consumables (LCD)
	The terminal for the external protective (earth) conductor		Power supply is out of temperature range (LCD)

Unpack the Powermax system

1. Verify that all items on your order have been received in good condition. Contact your distributor if any parts are damaged or missing.
2. Inspect the power supply for damage that may have occurred during shipping. If there is evidence of damage, refer to *Claims*. All communications regarding this equipment must include the model number and the serial number located on the back of the power supply.
3. Before you set up and operate this Hypertherm system, read the separate *Safety and Compliance Manual (80669C)* included with your system for important safety information.

Claims

- **Claims for damage during shipment** – If your unit was damaged during shipment, you must file a claim with the carrier. Hypertherm will furnish you with a copy of the bill of lading upon request. If you need additional assistance, call the nearest Hypertherm office listed in the front of this manual.
- **Claims for defective or missing merchandise** – If any component is missing or defective, contact your Hypertherm distributor. If you need additional assistance, call the nearest Hypertherm office listed in the front of this manual.

Contents

The following illustration shows typical system components. A vinyl cap is installed on torches that ship with new systems. Consumables are included in the starter consumable kit, and the small consumables box next to the air filter contains spare electrodes and nozzles.

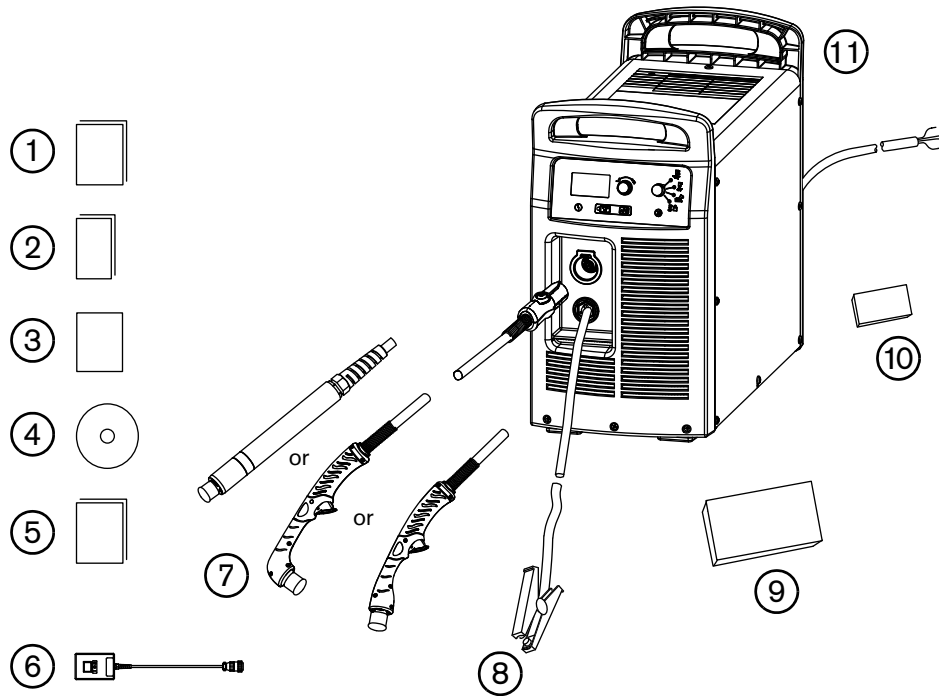

- | | |
|-----------------------------------|--|
| 1 Operator Manual | 7 Torches |
| 2 Quick Setup Card | 8 Ground clamp and work lead |
| 3 Registration card | 9 Starter consumable kit |
| 4 Setup DVD | 10 Box with extra consumables (located next to air filter) |
| 5 Safety and Compliance Manual | 11 Power supply |
| 6 Remote-start pendant (optional) | |

Position the power supply

Locate the power supply near an appropriate power receptacle for your installation:

- 480 V (3-phase, CSA certified)
- 600 V (3-phase, CSA certified)
- 400 V (3-phase, CE certified)
- 380 V (3-phase, CCC certified)

CSA and CE certified power supplies include a 3 m (10 foot) power cord (depending on the model). CCC certified power supplies do not ship with a power cord. To maintain CE certification, install power cord kit 228886.

Allow at least 0.25 m (10 inches) of space around the power supply for proper ventilation.

The power supply is not suitable for use in rain or snow.

To avoid toppling, do not set the power supply on an incline greater than 10 degrees.

Prepare the electrical power

Hypertherm (designated HYP on the data plate) input current ratings are used to determine conductor sizes for power connection and installation instructions. The HYP rating is determined under maximum normal operating conditions, and the higher HYP input current value should be used for installation purposes.

	CAUTION!
Protect the circuit with appropriately sized time-delay (slow-blow) fuses and a line-disconnect switch.	

The maximum output voltage will vary based on your input voltage and the circuit's amperage. Because the current draw varies during startup, slow-blow fuses are recommended as shown in *Power connection for the Powermax125* on page 28. Slow-blow fuses can withstand currents up to ten times the rated value for short periods of time.

Install a line-disconnect switch

Use a line-disconnect switch for each power supply so that the operator can turn off the incoming power quickly in an emergency. Locate the switch so that it is easily accessible to the operator. Installation must be performed by a licensed electrician according to national and local codes. The interrupt level of the switch must equal or exceed the continuous rating of the fuses. In addition, the switch should:

- Isolate the electrical equipment and disconnect all live conductors from the incoming supply voltage when in the OFF position.
- Have one OFF and one ON position that are clearly marked with **O** (OFF) and **I** (ON).
- Have an external operating handle that can be locked in the OFF position.
- Contain a power-operated mechanism that serves as an emergency stop.
- Have appropriate slow-blow fuses installed. See *Power connection for the Powermax125* on page 28 for recommended fuse sizes.

Requirements for grounding

To ensure personal safety, proper operation, and to reduce electromagnetic interference (EMI), the power supply must be properly grounded.

- The power supply must be grounded through the power cord according to national and local electrical codes.
- Three-phase service must be of the 4-wire type with a green or green/yellow wire for protective earth ground and must comply with national and local requirements.
- Refer to the separate *Safety and Compliance Manual* included with your system for more information on grounding.

2 – Power Supply Setup

Power connection for the Powermax125

Powermax125 3-phase systems are available in the following fixed-voltage configurations:

- 480 V CSA
- 600 V CSA
- 400 V CE
- 380 V CCC



To maintain CE certification, install power cord kit 228886.

The Hypertherm rated output is 30 – 125 A, 175 VDC.

Table 4 – 480 V CSA

Input voltage (V)	480
Input current (A) at rated output (21.9 kW)	31
Input current (A) at arc stretch	50
Fuse, slow-blow (A)	50
Voltage tolerance	+20% / -15%

Table 5 – 600 V CSA

Input voltage (V)	600
Input current (A) at rated output (21.9 kW)	24
Input current (A) at arc stretch	38
Fuse, slow-blow (A)	40
Voltage tolerance	+10% / -15%

Table 6 – 400 V CE

Input voltage (V)	400
Input current (A) at rated output (21.9 kW)	36
Input current (A) at arc stretch	55
Fuse, slow-blow (A)	60
Voltage tolerance	+20% / -15%

Table 7 – 380 V CCC

Input voltage (V)	380
Input current (A) at rated output (21.9 kW)	38
Input current (A) at arc stretch	55
Fuse, slow-blow (A)	60
Voltage tolerance	+20% / -15%

Three-phase power cord and plug installation

Powermax125 power supplies ship with the following power cords:

- CSA models: 8 AWG 4-wire power cord (no power plug included)
- CE models: 10 mm² 4-wire HAR power cord (no power plug included)

CCC certified configurations do not ship with a power cord. To maintain CE certification, install power cord kit 228886.

If you need to install a different power cord on the system, the cable you use must have a diameter within one of the following ranges to ensure a proper fit in the power cord strain relief:

- CSA and CCC models: 15.0 – 25.4 mm (0.59 – 1.00 inches)
- CE models: 20.0 – 25.9 mm (0.79 – 1.02 inches)

To operate the Powermax, use a plug that meets national and local electrical codes. The plug must be connected to the power cord by a licensed electrician.

Decrease output current for lower-rated power plugs

To operate the power supply at full output and 100% duty cycle as rated, you must size your electrical service accordingly. To operate the power supply using a lower-rated power plug or service, you must turn down the current (amperage setting).



For more information on setting the current, see *Adjusting the current (amperage)* on page 44.

Example: Table 8 shows the recommended output current for operating a 400 V CE power supply installed with a 32 A power plug. To operate at 400 V in this scenario, run the power supply at 109 A to maintain 100% duty cycle.

Table 8 – Recommended ratings for operating 400 V CE unit on 32 A power plug

Input voltage	Phase	Recommended output current to maintain 100% duty cycle
380 V	3	104 A
400 V	3	109 A
415 V	3	114 A

2 – Power Supply Setup

Strip and prepare the power cord wires as shown in the following figure. For CE units, ferrite cores are installed around the three power wires and around the ground wire; CSA and CCC models do not have ferrite cores on the power cord wires.

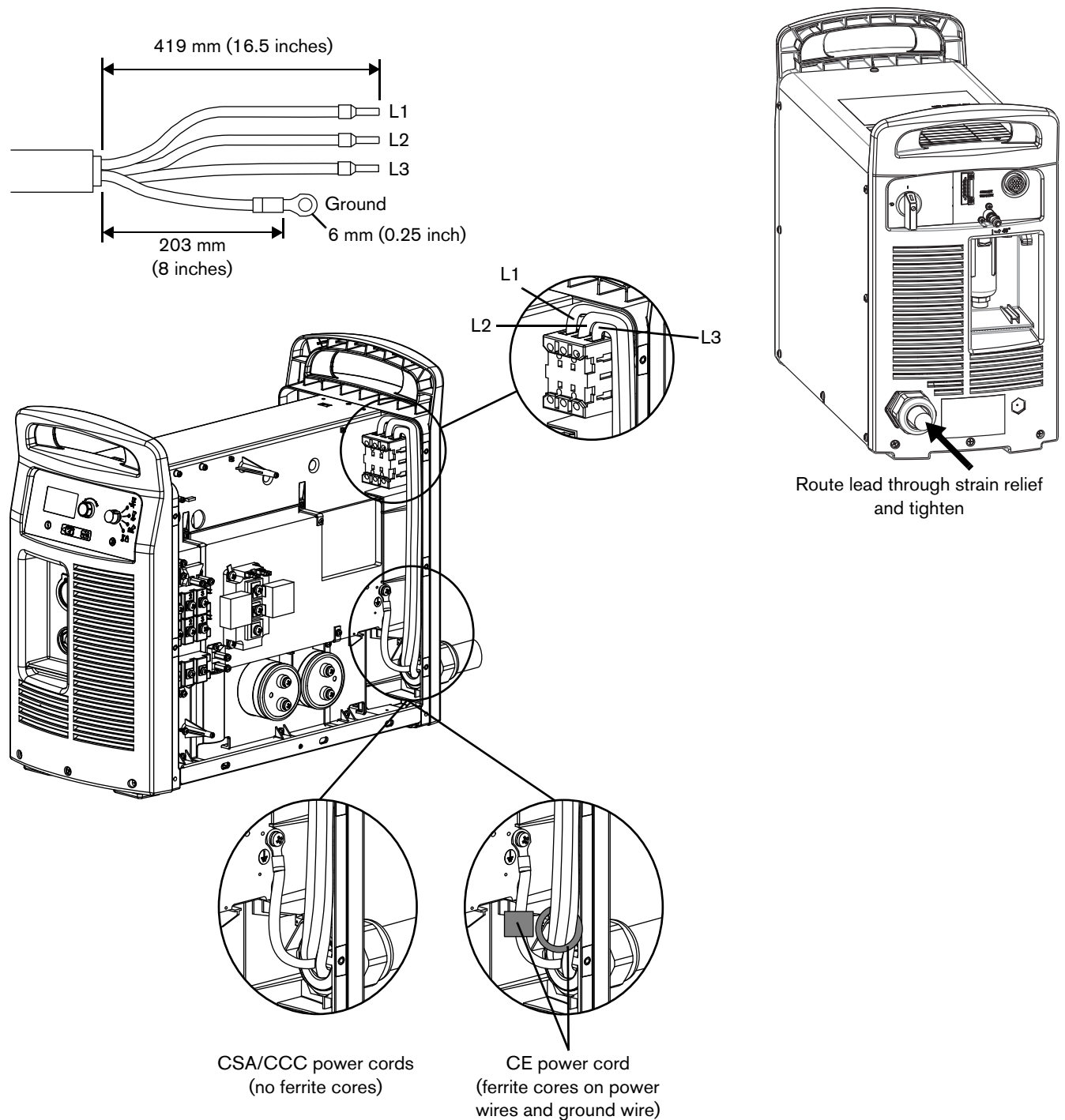

CCC models do not ship with a power cord. To maintain CE certification, install power cord kit 228886.

Extension cord recommendations

Any extension cord must have an appropriate wire size for the cord length and system voltage. Use a cord that meets national and local codes.

For all Powermax125 configurations, the recommended gauge size for any three-phase extension cord between 3 – 45 m (10 – 150 feet) is 10 mm² (8 AWG).

Engine-driven generator recommendations

Generators used with the Powermax125 should satisfy the voltage requirements in the following table and in *Hypertherm power supply ratings* on page 18.

Engine drive rating	System output current	Performance (arc stretch)
40 kW	125 A	Full
30 kW	125 A	Limited
30 kW	100 A	Full
25 kW	100 A	Limited
22.5 kW	75 A	Full
20 kW	75 A	Limited
20 kW	60 A	Full
15 kW	60 A	Limited
12 kW	40 A	Full
10 kW	40 A	Limited
10 kW	30 A	Full
8 kW	30 A	Limited



Based on the generator rating, age, and condition, adjust the cutting current as needed.



If a fault occurs while using a generator, turning the power switch quickly to OFF and then to ON again (sometimes called a “quick reset”) may not clear the fault. Instead, turn OFF the power supply and wait 60 to 70 seconds before turning it ON again.

Prepare the gas supply

The air can be supplied by a compressor or from high-pressure cylinders. A high-pressure regulator must be used on either type of supply and must be capable of delivering gas to the air inlet on the power supply at the flow rate and pressure specified in *Hypertherm power supply ratings* on page 18.

	CAUTION!
Synthetic lubricants containing esters that are used in some air compressors will damage polycarbonates used in the air regulator bowl.	

The system contains a built-in filter element, but additional filtration may be required depending on the quality of the gas supply. If the supply quality is poor, cut speeds decrease, cut quality deteriorates, cutting thickness capability decreases, and the life of the consumables shortens. To address these issues, use an optional air filtration system, such as the Hypertherm Eliminer filter kit (228890). For optimal performance, the gas should be compliant with ISO8573-1:2010, Class 1.2.2 (that is, it should have a maximum number of solid particulate per meter cubed of 20,000 for particle sizes in the range of 0.1 – 0.5 microns, a maximum of 400 for particle sizes in the range of 0.5 – 1 microns, and a maximum of 10 for particle sizes in the range of 1 – 5 microns). The maximum water vapor dew point should be -40° C (-40° F). The maximum oil (aerosol, liquid, and vapor) content should be 0.1 mg/m³.

Additional gas filtration

When site conditions introduce moisture, oil, or other contaminants into the gas line, use a 3-stage coalescing filtration system. A 3-stage filtering system works as follows to clean contaminants from the gas supply.

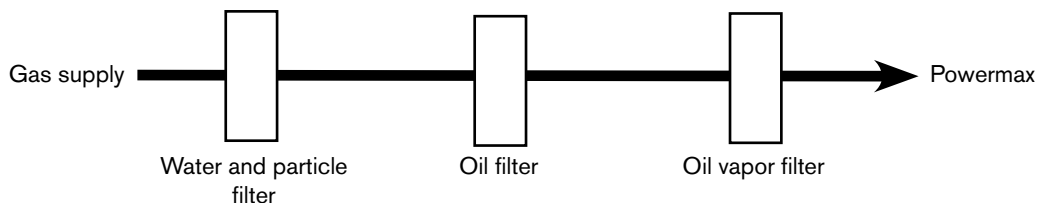

The filtering system should be installed between the gas supply and the power supply. Additional gas filtration may require higher pressure from the source.

Connect the gas supply

Connect the gas supply to the power supply using an inert-gas hose with a 9.5 mm (3/8 inch) internal diameter and a 1/4 NPT quick-disconnect coupler (CSA units) or a 1/4 NPT x G-1/4 BSPP (CE/CCC units) quick-disconnect coupler.

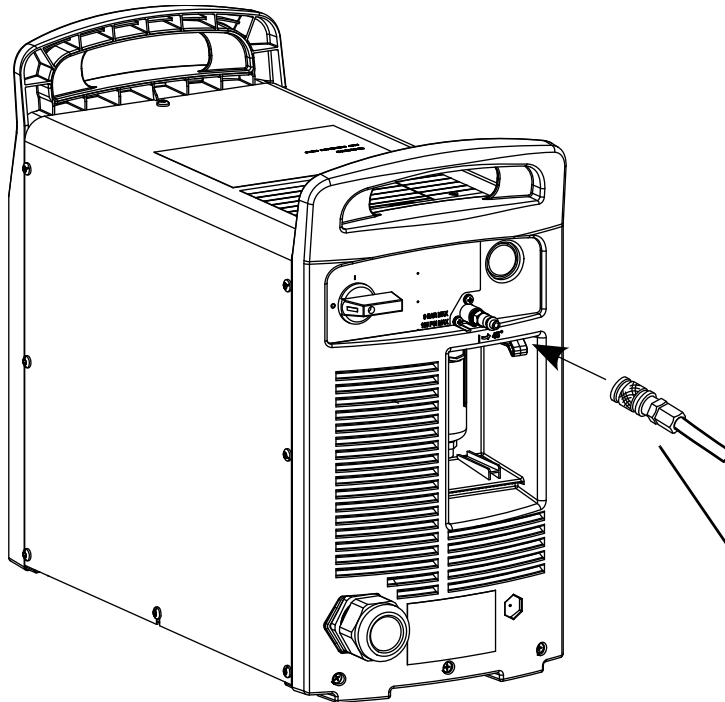

The recommended inlet pressure while gas is flowing is 5.9 – 9.3 bar (85 – 135 psi).



WARNING!

Do not allow the gas supply pressure to exceed 9.3 bar (135 psi). The filter bowl may explode if this pressure is exceeded.

2 – Power Supply Setup

Minimum inlet pressure (while gas is flowing)

This table shows the minimum required inlet pressure when the recommended inlet pressure is not available.

Torch lead length	7.6 m (25 feet)	15.2 m (50 feet)	22.9 m (75 feet)
Process	Minimum inlet pressure		
Cutting	5.9 bar (85 psi)	5.9 bar (85 psi)	6.6 bar (95 psi)
Gouging	4.1 bar (60 psi)	4.1 bar (60 psi)	4.1 bar (60 psi)

Gas flow rates

Process	Gas flow rate
Cutting	260 slpm (550 scfh, 9.2 scfm) at a minimum: <ul style="list-style-type: none">▪ 5.9 bar (85 psi) for 7.6 m (25 foot) and 15 m (50 foot) torches▪ 6.6 bar (95 psi) for 23 m (75 foot) torches
Gouging	212 slpm (450 scfh, 7.5 scfm) at a minimum 4.1 bar (60 psi)

Controls and indicators

Powermax power supplies have the following controls and indicators: ON/OFF switch, adjustment knob, automatic/manual pressure setting mode selector, current/gas selector, operating mode switch, indicator LEDs, and a status screen. These controls and indicators are described on the following pages.

Rear controls

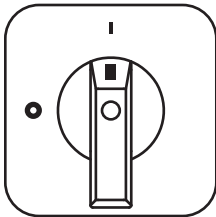

ON (I)/OFF (O) power switch – Activates the power supply and its control circuits.

Front controls and LEDs

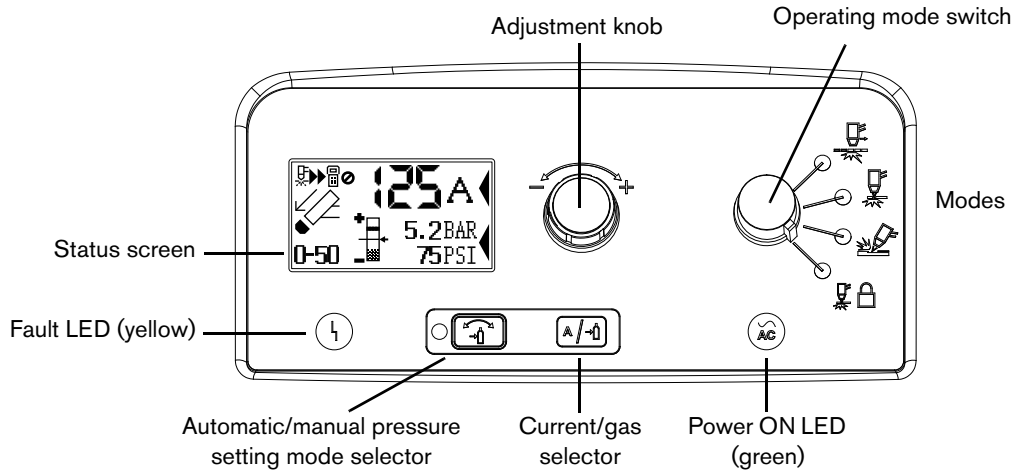

LEDs



Power ON LED (green) – When illuminated, this LED indicates that the power switch has been set to I (ON) and that the safety interlocks are satisfied. When blinking, the power supply has a fault.



Fault LED (yellow) – When illuminated, this LED indicates that there is a fault with the power supply.

Selectors



Automatic/manual pressure setting mode selector – The selector switches between automatic and manual mode. In automatic mode, the power supply automatically sets the gas pressure based on the torch type and lead length, and the adjustment knob sets only the amperage. In manual mode, the adjustment knob sets either the gas pressure or the amperage. This LED is illuminated in manual mode.



Manual mode should be used by experienced users who need to optimize the gas setting (override the automatic gas setting) for a specific cutting application.

When you switch from manual mode to automatic mode, the power supply automatically sets the gas pressure, and the amperage setting is unchanged. When you switch from automatic mode to manual mode, the power supply remembers the previous manual gas pressure setting, and the amperage setting is unchanged.

When you reset the power, the power supply remembers the previous mode, gas pressure, and amperage settings.

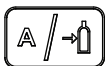

Current/gas selector – When in manual mode, this selector toggles between amperage and gas pressure for manual adjustments using the adjustment knob.

Operating mode switch

For more information on these modes, see *Set the operating mode switch* on page 43.

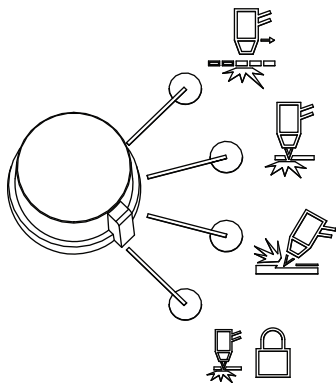

The operating mode switch can be set in one of four positions:

- Continuous pilot arc. Cuts expanded metal or grate.
- Non-continuous pilot arc. Cuts or pierces metal plate. This is the standard setting for normal drag-cutting.
- Gouge. Gouges metal plate.
- Torch lock. Same as the non-continuous pilot arc mode except the torch is locked in the ON position when you release the trigger during a cut. The torch goes out when the transfer is lost or the torch is retriggered.

Amperage adjustment knob

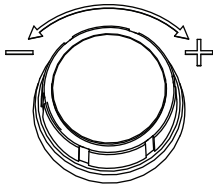

This knob adjusts the amperage. When operating in manual mode, you can also use this knob to adjust the gas pressure, overriding the automatic setting for optimized applications.

Status screen

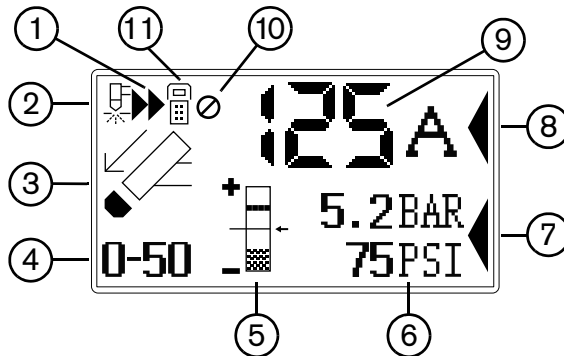

- | | |
|--|--|
| <ul style="list-style-type: none"> 1 Torch is cutting 2 Torch start 3 Fault icon 4 Fault code 5 Visual pressure setting 6 Pressure setting | <ul style="list-style-type: none"> 7 Pressure selection cursor 8 Current selection cursor 9 Current setting (amperage) 10 Electrode end of life detection manually disabled 11 Remote connected |
|--|--|

3 – Basic System Operations

Gas pressure indicators

In manual mode, the gas pressure is displayed in measurements of bar and psi. The gas pressure bar is also a visual indicator of the gas pressure.

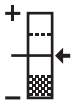

Gas pressure bar – When the arrow is centered in the vertical bar (the reference pressure of the automatic pressure setting), the gas pressure is set to the preset (factory-defined) value. If the pressure is higher than the preset value, the arrow appears above the mid-point of the bar. If the pressure is lower than the preset value, the arrow appears below the mid-point of the bar.



In automatic mode, the power supply adjusts the pressure to the preset value. You can use manual mode to adjust the pressure to satisfy the needs of a particular cutting job. See *Manually adjusting the gas pressure* on page 44.

System status icons

The screen displays icons to indicate the system's status.



Torch started – Indicates that the torch has received a start signal.



Torch is cutting – Indicates that the cutting arc has transferred to the metal, and the torch is cutting.



Remote control – Indicates that a remote control or CNC is controlling the power supply using serial communications. All local controls are disabled.



Electrode end-of-life detection manually disabled – Indicates that the electrode end-of-life detection feature is manually disabled.

Fault codes and icons

When a power supply or torch fault occurs, the system displays a fault code in the lower-left corner of the status screen and displays a corresponding fault icon above the code.

0-50

Fault code – The first digit is always zero. The other two digits identify the problem. Fault code information is included later in this manual.



Only one fault code is displayed. If more than one fault occurs at the same time, only the fault code with the highest priority is displayed.

Fault icon – The fault icons that appear on the left side of the status screen are described below. A fault code also appears to identify the fault. Refer to the troubleshooting information later in this manual.



Warning – The system continues to run.



Fault – The system stops cutting. If you cannot correct the problem and restart the system, contact your distributor or Hypertherm Technical Service.



Error – The system requires service. Contact your distributor or Hypertherm Technical Service.



Torch cap sensor – Indicates that the consumables are loose, improperly installed, or missing. Turn OFF the power, properly install the consumables, and turn ON the system again to reset the power supply.



Temperature – Indicates that the temperature of the power supply power module is outside the acceptable operating range.



Gas – Indicates that the gas is disconnected from the rear of the power supply or there is a problem with the gas supply.



Internal Serial Communications Interface – Indicates a problem with communications between the control board and the DSP board.

Operating the Powermax

Follow the steps below to begin cutting or gouging with the system.

 This section provides basic operating instructions. Before operating your system in a production environment, refer to *Hand Torch Setup* on page 47 or *Machine Torch Setup* on page 63.

Connect the electrical power, gas supply, and torch lead

For information on connecting the proper plug to the power cord, refer to *Power Supply Setup* on page 25.

Plug in the power cord and connect the gas supply line. For more information about the electrical requirements and the gas supply requirements of the Powermax, see *Power Supply Setup* on page 25. To connect the torch, push the FastConnect connector into the receptacle on the front of the power supply. You will attach the work lead in the next step.

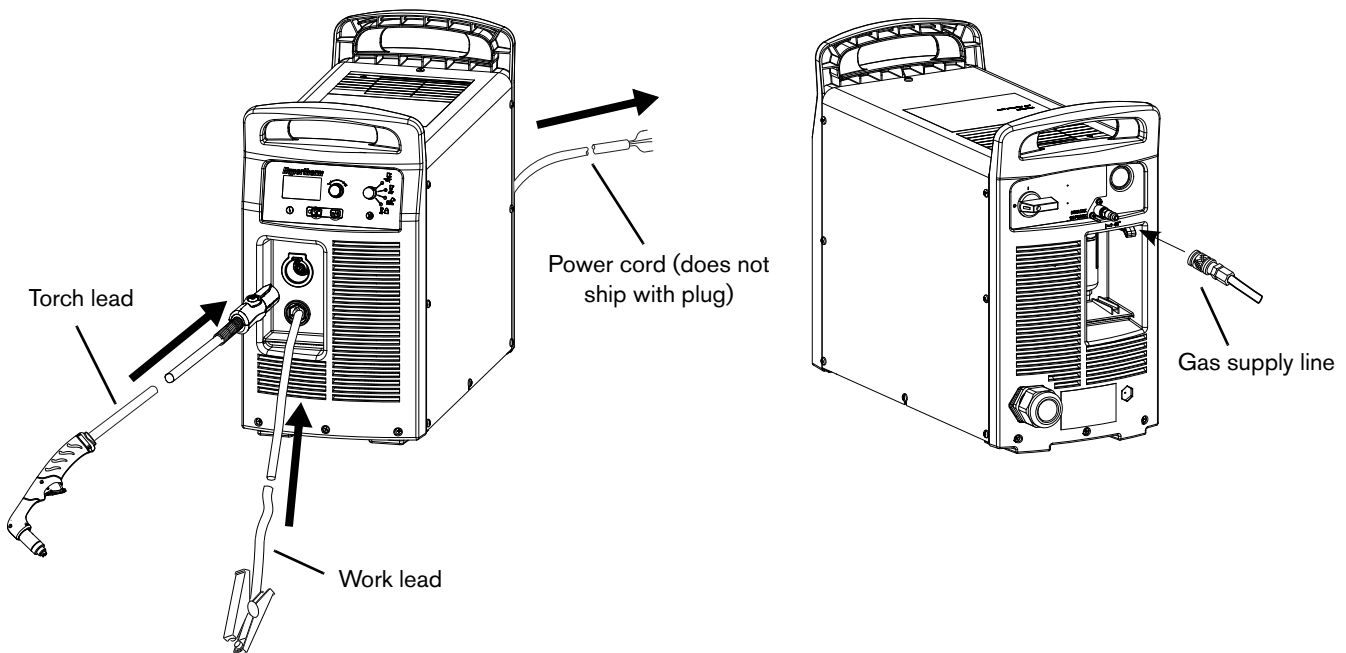

 CCC units do not ship with a power cord. To maintain CE certification, install power cord kit 228886.

Attach the work lead to the power supply



CAUTION!

Make sure you use a work lead that is appropriate for your power supply. Use a 125 A work lead with the Powermax125. The amperage is marked near the rubber boot of the work lead connector.

1. Insert the work lead connector into the receptacle on the front of the power supply.



The receptacle is keyed. Align the key on the work lead connector with the opening at the top of the receptacle on the power supply.

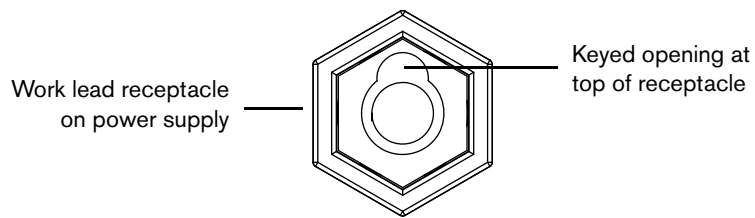

2. Push the work lead connector all the way into the receptacle on the power supply and turn clockwise, approximately 1/4 turn, until the connector is fully seated against the stop in order to achieve an optimal electrical connection.



A loose connection will overheat the connector. Frequently check the work lead for a reliable electrical connection.





CAUTION!

Make sure the work lead is fully seated in the receptacle to prevent overheating.

Attach the ground clamp to the workpiece

The ground clamp must be connected to the workpiece while you are cutting. If you are using the Powermax with a cutting table, you can connect the work lead directly to the table instead of attaching the ground clamp to the workpiece. See your table manufacturer's instructions.

-  Make sure that the ground clamp and the workpiece make good metal-to-metal contact. Remove rust, dirt, paint, coatings, and other debris to ensure the work lead makes proper contact with the workpiece.
-  For the best cut quality, attach the ground clamp as close as possible to the area being cut.

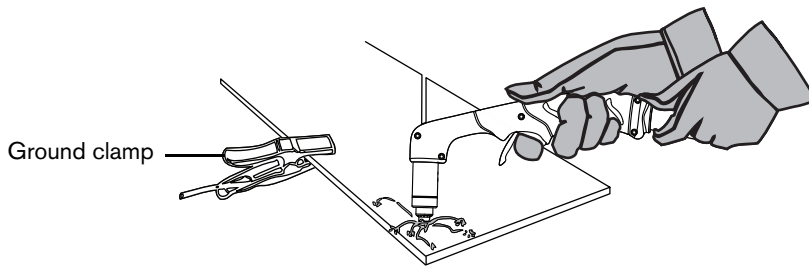

CAUTION!

Do not attach the ground clamp to the portion of the workpiece to be cut away.

Turn on the system

Set the ON/OFF switch to the ON (I) position.

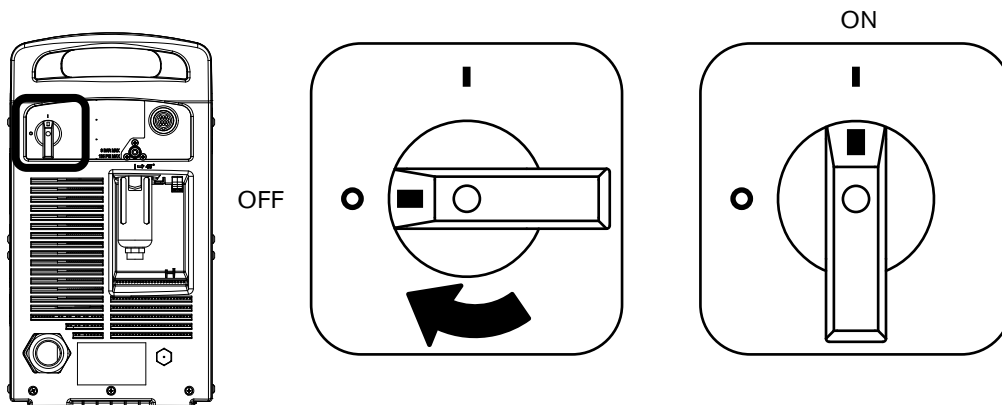

Set the operating mode switch

Use the operating mode switch to select the type of work you want to perform.

In automatic gas mode, Smart Sense technology automatically adjusts the gas pressure according to the selected cutting mode and torch lead length for optimum cutting.

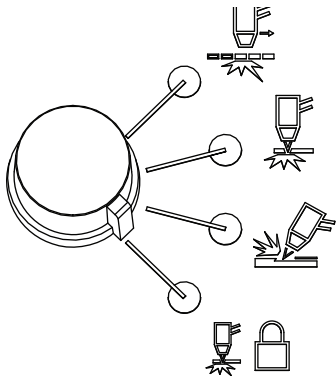

For cutting expanded metal, grates, metal containing holes, or any job that requires a continuous pilot arc. Using this mode to cut standard metal plate reduces consumable life.

For cutting or piercing metal. This is the standard setting for normal drag-cutting.

For gouging metal.



Using this mode while cutting results in poor cut quality.

For locking the torch in the ON (fire) position. With this option selected, press the trigger to fire the torch. The trigger will remain on when you release the trigger. The arc will go out when transfer is lost or you press the trigger again.

Check the indicators

Verify the following:

- The green power ON LED on the front of the power supply is illuminated.
- The Fault LED is *not* illuminated.
- No error icons appear in the status screen.

If a fault icon appears in the status screen, or the Fault LED is illuminated, or the power ON LED is blinking, correct the fault condition before continuing. More troubleshooting information is included later in this manual.

Manually adjusting the gas pressure

For normal operations, the power supply automatically adjusts the gas pressure. If you need to adjust the gas pressure for a specific application, you can use manual mode to do so.



Manual mode should be used by experienced users who need to optimize the gas setting (override the automatic gas setting) for a specific cutting application.

When you switch from manual mode to automatic mode, the power supply automatically sets the gas pressure, and the amperage setting is unchanged. When you switch from automatic mode to manual mode, the power supply remembers the previous manual gas pressure setting, and the amperage setting is unchanged.

When you reset the power, the power supply remembers the previous mode, gas pressure, and amperage settings.

To adjust the pressure:

1. Press the automatic/manual pressure setting mode selector so that the LED next to the selector illuminates. Refer to *Front controls and LEDs* on page 36.
2. Press the current/gas selector until the selection cursor is opposite the gas pressure setting in the status screen.
3. Turn the adjustment knob to adjust the gas pressure to the desired level. Watch the arrow in the pressure bar as you adjust the pressure. (See *Gas pressure indicators* on page 38.)

Adjusting the current (amperage)

Turn the adjustment knob to adjust the current for your particular cutting application.

If the system is in manual mode, do the following to adjust the amperage:

1. Press the current/gas selector until the selection cursor is opposite the amperage setting in the status screen.
2. Turn the adjustment knob to change the amperage.
3. If you wish to exit manual mode, press the automatic/manual pressure setting mode selector. The LED goes off.



When you exit manual mode, the gas pressure resets to the factory-optimized value.

When you switch between manual mode and automatic mode, the power supply retains the amperage setting. When you reset the power, the power supply returns to the previous mode (automatic mode or manual mode) and remembers the previous amperage setting.

Electrode end-of-life detection feature

The electrode end-of-life detection feature on the system protects the torch and workpiece from damage by automatically stopping power to the torch when the electrode reaches its end of life. Fault code 0-32 also displays on the front panel status screen. If you have the current set below 55 A, this feature is automatically disabled without displaying the icon on the status screen.

To manually disable the feature:

1. Set the system to auto mode.
2. Press the current/gas selector button (see *Figure 1*) 5 times in quick succession, less than one second apart.
The icon (see *Figure 1*) displays on the status screen.
3. To re-enable the feature, press the current/gas selector button 5 times again in quick succession, less than one second apart.
The icon disappears.

Figure 1 – Front panel controls

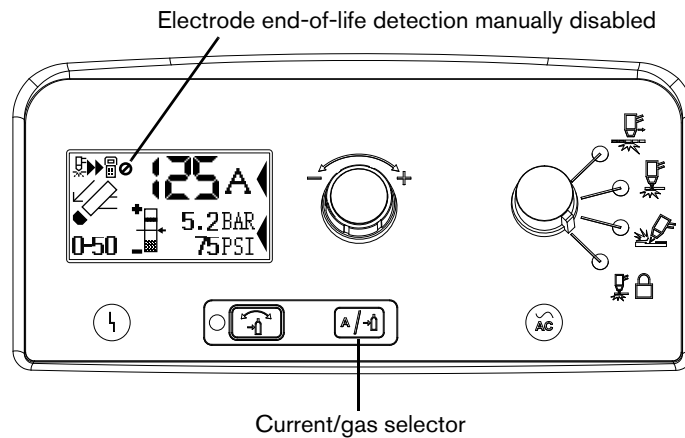

Understanding duty-cycle limitations

The duty cycle is a percentage of time out of 10 minutes that a plasma arc will remain on when operating at an ambient temperature of 40° C (104° F). For example, if the system runs for 6 minutes before overheating and cools off enough to produce an arc in less than 4 minutes, it has a 60% duty cycle.

If the power supply overheats, the temperature fault icon appears in the status screen, the arc shuts off, and the cooling fan continues to run. You cannot resume cutting until the temperature fault icon disappears and the fault LED goes off.



The fan may run during normal operation of the system.

With a Powermax125:

- At 125 A (480/600 V CSA, 400 V CE, 380 V CCC), the arc can remain on for 10 minutes out of 10 minutes without causing the unit to overheat (100% duty cycle).



If you are operating the power supply using a lower-rated power plug or service, turn down the current (amperage setting). See *Decrease output current for lower-rated power plugs* on page 29.

Introduction

Duramax Hyamp series hand torches are available for Powermax125 systems. The FastConnect quick-disconnect system makes it easy to remove the torch for transport or to switch from one torch to the other if your applications require the use of different torches. The torches are cooled by ambient air and do not require special cooling procedures.

This section explains how to set up your hand torch and choose the appropriate consumables for the job.

Consumable life

How often you need to change the consumables on your torch will depend on a number of factors:

- The thickness of the metal being cut.
- The average length of the cut.
- The air quality (presence of oil, moisture, or other contaminants).
- Whether you are piercing the metal or starting cuts from the edge.
- Proper torch-to-work distance when gouging.
- Proper pierce height.
- Whether you are cutting in “continuous pilot arc” mode or normal mode. Cutting with a continuous pilot arc causes more consumable wear.

Under normal conditions, the nozzle will wear out first when hand cutting. As general rule, a set of consumables lasts approximately 1 to 3 hours of actual “arc on” time for 125 A hand cutting. Cutting at lower amperages may yield longer consumable life.

You will find more information about proper cutting techniques in *Hand Cutting* on page 53.

4 – Hand Torch Setup

Hand torch components

The hand torches ship without consumables installed.

Duramax Hyamp 85° hand torch

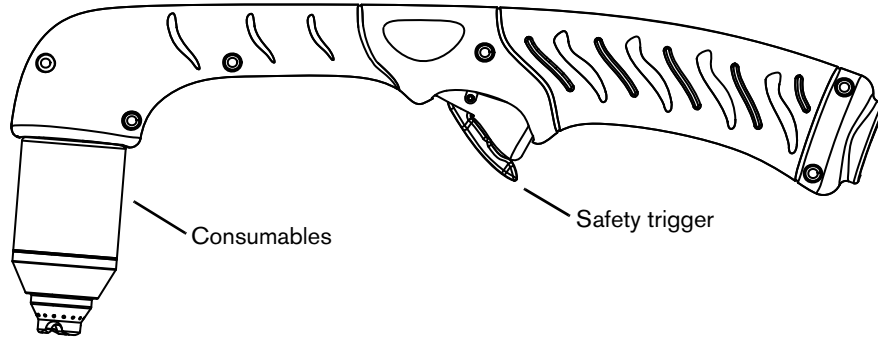

Duramax Hyamp 15° hand torch

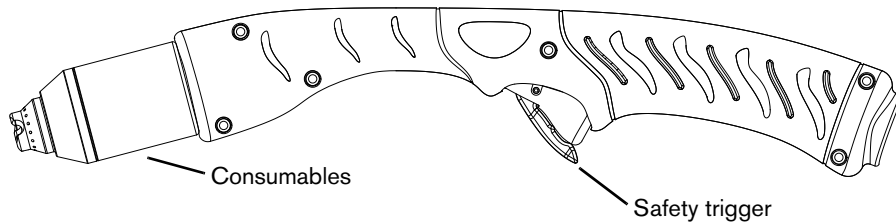

Choose the hand torch consumables

Hypertherm includes a starter consumable kit and a box of spare electrodes and nozzles with your system. Both styles of hand torches shown above use the same consumables.

Hand torches use shielded consumables. Therefore, you can drag the torch tip along the metal.

Consumables for hand cutting are shown below. Notice that the retaining cap and electrode are the same for cutting, gouging, and FineCut® applications. Only the shield, nozzle, and swirl ring are different.

For the best cut quality on thin materials (approximately 4 mm/10 GA or less), you may prefer to use FineCut consumables, or use a 45 A nozzle and reduce the amperage to that setting.

Drag-cutting 105/125 A consumables



420000
Shield

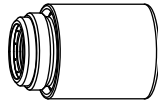

220977
Retaining cap



220975
Nozzle

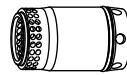

220997
Swirl ring

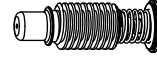

220971
Electrode

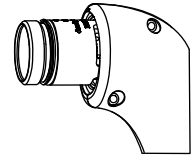

Drag-cutting 45 A and 65 A consumables



420172
Shield

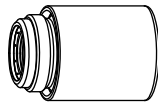

220977
Retaining cap



420158 (45 A)
420169 (65 A)
Nozzle

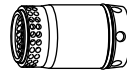

220997
Swirl ring

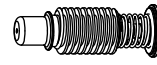

220971
Electrode

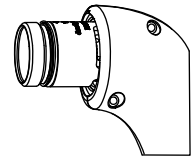

Gouging consumables

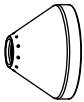

420112
Shield

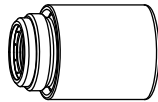

220977
Retaining cap



420001
Nozzle

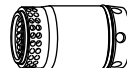

220997
Swirl ring

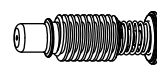

220971
Electrode

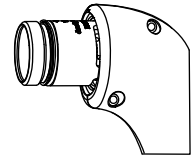

FineCut consumables



420152
Shield

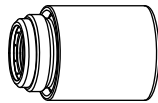

220977
Retaining cap



420151
Nozzle

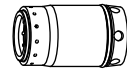

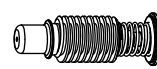

420159
Swirl ring

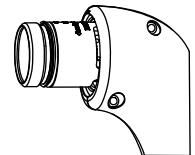

220971
Electrode

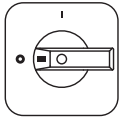

Install the hand torch consumables

		WARNING! INSTANT-ON TORCHES PLASMA ARC CAN CAUSE INJURY AND BURNS
	The plasma arc comes on immediately when the torch trigger is activated. Make sure the power is OFF before changing consumables.	

To operate the hand torch, a complete set of consumable parts must be installed: shield, retaining cap, nozzle, electrode, and swirl ring. Torches ship without consumables installed. Pull off the vinyl cap before installing your consumables.

With the power switch in the OFF (O) position, install the Powermax125 torch consumables as shown.

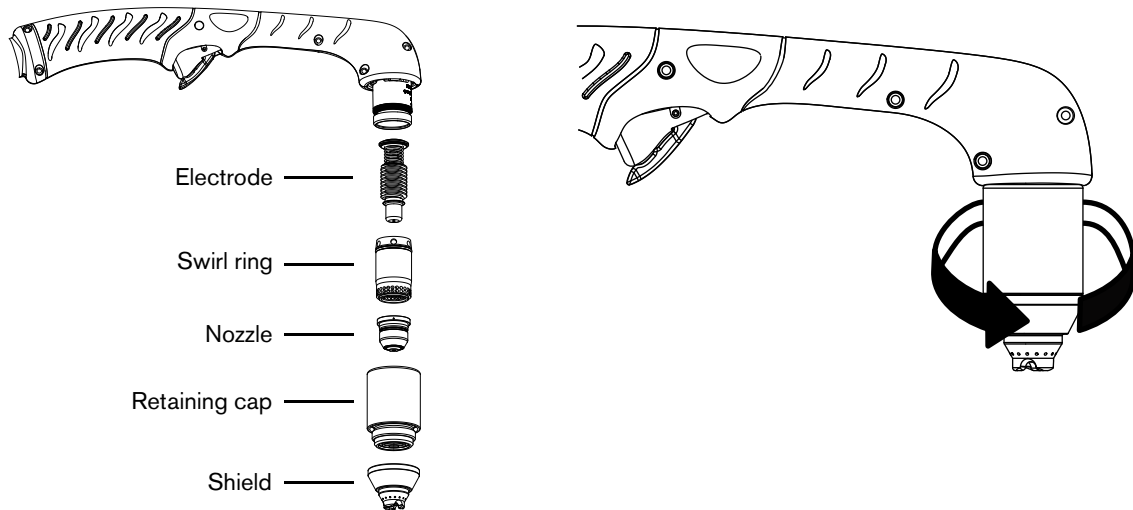

Connecting the torch lead

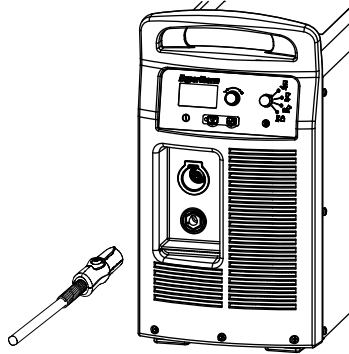

The system is equipped with FastConnect, a quick-disconnect system for connecting and disconnecting handheld and machine torch leads. When connecting or disconnecting a torch, first turn OFF the system. To connect the torch, push the connector into the receptacle on the front of the power supply.

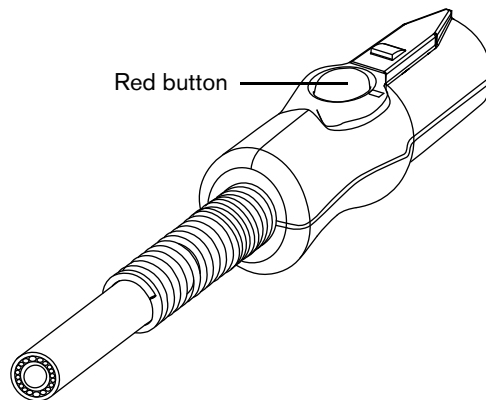

To remove the torch, press the red button on the connector and pull the connector out of the receptacle.



Using the hand torch

		WARNING! INSTANT-ON TORCHES PLASMA ARC CAN CAUSE INJURY AND BURNS
<p>Plasma arc comes on immediately when the torch trigger is activated. The plasma arc will cut quickly through gloves and skin.</p> <ul style="list-style-type: none">■ Wear correct and appropriate protective equipment.■ Keep hands, clothing, and objects away from the torch tip.■ Do not hold the workpiece and keep your hands clear of the cutting path.■ Never point the torch toward yourself or others.		

Operate the safety trigger

The hand torches are equipped with a safety trigger to prevent accidental firings. When you are ready to use the torch, flip the trigger's safety cover forward (toward the torch head) and press the red torch trigger.

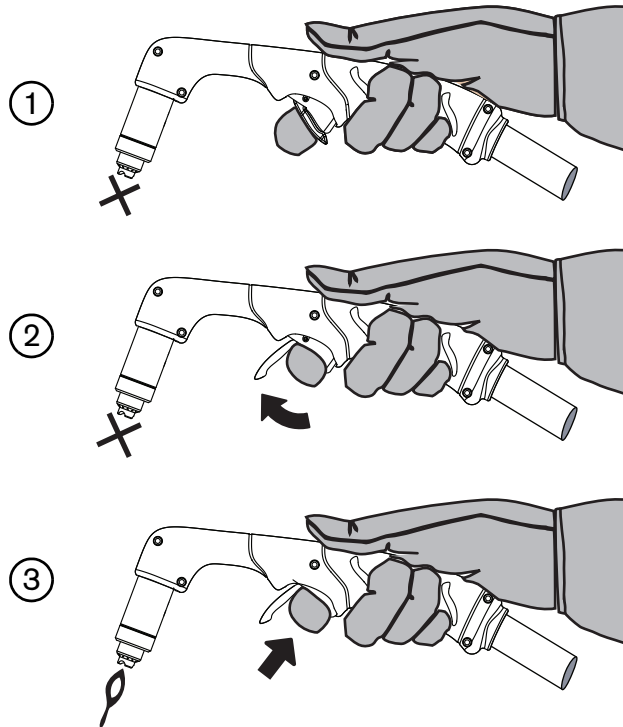

Hand torch cutting guidelines

- Drag the torch tip lightly along the workpiece to maintain a steady cut.
- While cutting, make sure that sparks exit from the bottom of the workpiece. The sparks should lag slightly behind the torch as you cut (15 – 30° angle from vertical).
- If sparks spray up from the workpiece, move the torch more slowly, or set the output current higher.
- With either hand torch, hold the torch nozzle perpendicular to the workpiece so that the nozzle is at a 90° angle to the cutting surface. Observe the cutting arc as the torch cuts.

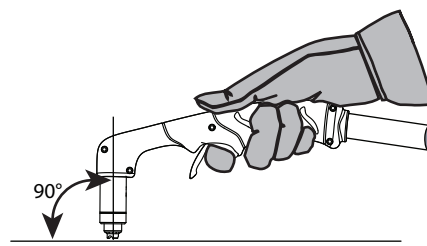

- If you fire the torch unnecessarily, you will shorten the life of the nozzle and electrode.

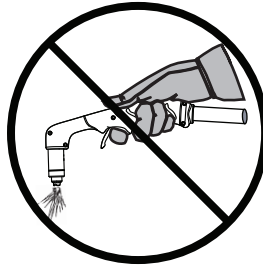

- Pulling, or dragging, the torch along the cut is easier than pushing it.
- For straight-line cuts, use a straight edge as a guide. To cut circles, use a template or a radius cutter attachment (a circle cutting guide).

Start a cut from the edge of the workpiece

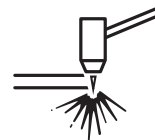

1. With the ground clamp attached to the workpiece, hold the torch nozzle perpendicular (90°) to the edge of the workpiece.



2. Press the torch's trigger to start the arc. Pause at the edge until the arc has cut completely through the workpiece.





5 – Hand Cutting

3. Drag the torch tip lightly across the workpiece to proceed with the cut. Maintain a steady, even pace.

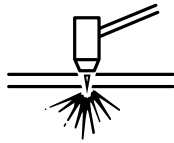

Pierce a workpiece

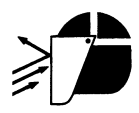

		<p style="text-align: center;">WARNING!</p> <p style="text-align: center;">SPARKS AND HOT METAL CAN INJURE EYES AND BURN SKIN</p>
<p>When firing the torch at an angle, sparks and hot metal will spray out from the nozzle. Point the torch away from yourself and others. Always wear proper protective equipment including gloves and eye protection.</p>		

1. With the ground clamp attached to the workpiece, hold the torch at an approximate 30° angle to the workpiece with the torch tip within 1.5 mm (1/16 inch) of the workpiece before firing the torch.



2. Fire the torch while still at an angle to the workpiece. Slowly rotate the torch to a perpendicular (90°) position.



3. Hold the torch in place while continuing to press the trigger. When sparks exit below the workpiece, the arc has pierced the material.



4. When the pierce is complete, drag the nozzle lightly along the workpiece to proceed with the cut.

Gouge a workpiece

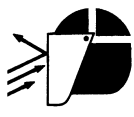
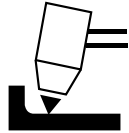

WARNING!

SPARKS AND HOT METAL CAN INJURE EYES AND BURN SKIN

When firing the torch at an angle, sparks and hot metal will spray out from the nozzle. Point the torch away from yourself and others. Always wear proper protective equipment including gloves and eye protection.

1. Hold the torch so that the torch tip is slightly above the workpiece before firing the torch.
2. Hold the torch at a 30 – 45° angle to the workpiece, with a small gap between the torch tip and the workpiece. Press the trigger to obtain a pilot arc. Transfer the arc to the workpiece.

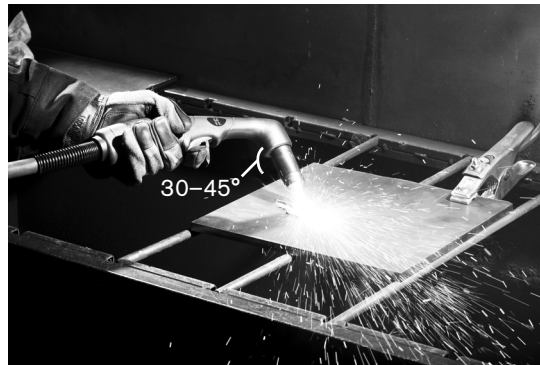

3. Change the torch's angle as needed to achieve the desired dimensions for the gouge. Refer to *Varying the gouge profile* on page 60 and *125 A gouging profile chart* on page 60.
4. Maintain the same angle to the workpiece as you feed into the gouge. Push the plasma arc in the direction of the gouge you want to create. Keep a small distance between the torch tip and the molten metal to avoid reducing consumable life or damaging the torch.



Gouge profile

- You can vary the gouge profile by varying the:
- Speed of the torch over the workpiece
- Torch-to-work standoff distance
- Angle of the torch to the workpiece
- Current output of the power supply

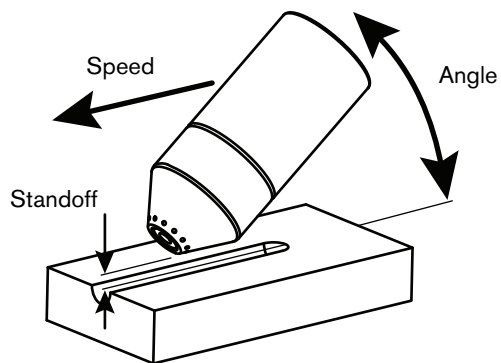

Operating parameters	
Speed	508 – 1270 mm/min (20 – 50 ipm)
Standoff	6.4 – 10.2 mm (1/4 – 2/5 inch)
Angle	30 – 35°

Typical gouging profile

125 A

Metal removal rate on mild steel 12.5 kg/hour
(27 pounds/hour)

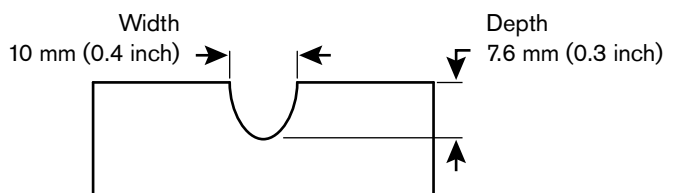

Varying the gouge profile

Follow these recommendations to change the gouge profile as needed:

- **Increasing the speed** of the torch will **decrease width** and **decrease depth**.
- **Decreasing the speed** of the torch will **increase width** and **increase depth**.
- **Increasing the standoff** of the torch will **increase width** and **decrease depth**.
- **Decreasing the standoff** of the torch will **decrease width** and **increase depth**.
- **Increasing the angle** of the torch (more vertical) will **decrease width** and **increase depth**.
- **Decreasing the angle** of the torch (less vertical) will **increase width** and **decrease depth**.
- **Increasing the current** of the power supply will **increase width** and **increase depth**.
- **Decreasing the current** of the power supply will **decrease width** and **decrease depth**.

125 A gouging profile chart

The following tables show the 125 A gouging profile at 30° and 35° on mild steel. These settings are intended to serve as a starting point to help you determine the best gouging profile for a given cutting job. Adjust these settings as needed for your application and table to obtain the desired result.

Table 9 – Metric

Torch angle	Standoff (mm)	Speed (mm/min)	Depth (mm)	Width (mm)	Width/depth ratio
30°	6.3	508	7.9	8.4	1.06
		762	6.6	7.6	1.16
		1016	5.5	6.6	1.21
		1270	4.4	6.1	1.38
	10.1	508	7.6	9.8	1.30
		762	6.1	8.7	1.43
		1016	4.8	7.3	1.50
		1270	4.2	7.0	1.66
35°	6.3	508	7.5	6.8	0.92
		762	5.7	6.5	1.13
		1016	4.5	5.7	1.26
		1270	4.2	5.2	1.24
	10.1	508	7.3	8.1	1.12
		762	5.7	7.5	1.30
		1016	5.7	6.4	1.12
		1270	4.4	6.0	1.35

Table 10 – English

Torch angle	Standoff (inches)	Speed (ipm)	Depth (inches)	Width (inches)	Width/depth ratio
30°	0.25	20	0.31	0.33	1.06
		30	0.26	0.30	1.16
		40	0.22	0.26	1.21
		50	0.17	0.24	1.38
	0.40	20	0.30	0.39	1.30
		30	0.24	0.34	1.43
		40	0.19	0.29	1.50
		50	0.17	0.28	1.66
35°	0.25	20	0.30	0.27	0.92
		30	0.23	0.26	1.13
		40	0.18	0.22	1.26
		50	0.17	0.21	1.24
	0.40	20	0.29	0.32	1.12
		30	0.23	0.30	1.30
		40	0.23	0.25	1.12
		50	0.18	0.24	1.35

Common hand-cutting faults

The torch does not cut completely through the workpiece. The causes can be:

- The cut speed is too fast.
- The consumables are worn.
- The metal being cut is too thick for the selected amperage.
- Gouging consumables are installed instead of drag-cutting consumables.
- The ground clamp is not attached properly to the workpiece.
- The gas pressure or gas flow rate is too low.
- Gouging mode is selected on the power supply.

Cut quality is poor. The causes can be:

- The metal being cut is too thick for the amperage.
- The wrong consumables are being used (gouging consumables are installed instead of drag-cutting consumables, for example).
- The torch is moving too quickly or too slowly.

The arc sputters and consumable life is shorter than expected. The causes can be:

- Moisture in the gas supply.
- Incorrect gas pressure.
- Consumables incorrectly installed.
- The consumables are worn.

Section 6

Machine Torch Setup

Introduction

Duramax Hyamp series machine torches are available for this system. The FastConnect quick-disconnect system makes it easy to remove the torch for transport or to switch from one torch to the other if your applications require the use of different torches. The torches are cooled by ambient air and do not require special cooling procedures.

This section explains how to set up your machine torch and choose the appropriate consumables for the job.

Consumable life

How often you need to change the consumables on your torch will depend on a number of factors:

- The thickness of the metal being cut.
- The average length of the cut.
- The air quality (presence of oil, moisture, or other contaminants).
- Whether you are piercing the metal or starting cuts from the edge.
- Proper torch-to-work distance when gouging.
- Proper pierce height.
- Whether you are cutting in “continuous pilot arc” mode or normal mode. Cutting with a continuous pilot arc causes more consumable wear.

Under normal conditions, the electrode will wear out first during machine cutting. As general rule, a set of consumables should last about 1 to 3 hours for 125 A mechanized cutting, depending on the job. Cutting at lower amperages may yield longer consumable life.

You will find more information about proper cutting techniques in *Mechanized Cutting* on page 95.

Machine torch components

Duramax Hyamp 180° machine torch

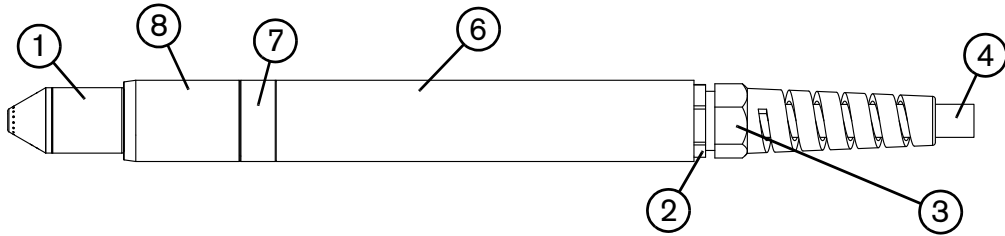

See the following callout table.

Duramax Hyamp 180° mini machine torch

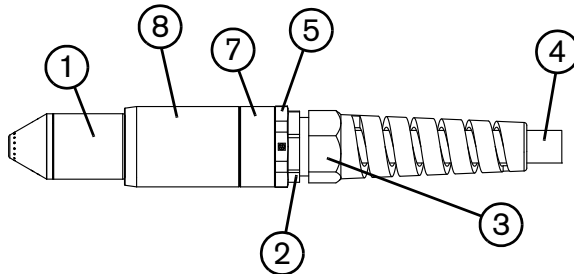

- | | |
|---------------------|---|
| 1 Consumables | 5 Adapter (not used in the full-length machine torch) |
| 2 Strain relief | 6 Positioning sleeve (not used in the mini machine torch) |
| 3 Strain relief nut | 7 Coupler |
| 4 Torch lead | 8 Mounting sleeve |

Before using either style of machine torch, you must:

- Mount the torch on your cutting table or other equipment.
- Choose and install the consumables.
- Align the torch square to the plate.
- Attach the torch lead to the power supply.
- Set up the power supply for remote starting with either the remote-start pendant or a machine interface cable.

Disassemble the machine torch

You may need to disassemble the machine torch in order to mount it on a cutting table (see *Mount the torch* on page 68). Another reason to disassemble the machine torch is to convert it from the full-length machine torch to a mini machine torch (see *Convert a full-length machine torch to a mini machine torch* on page 67).

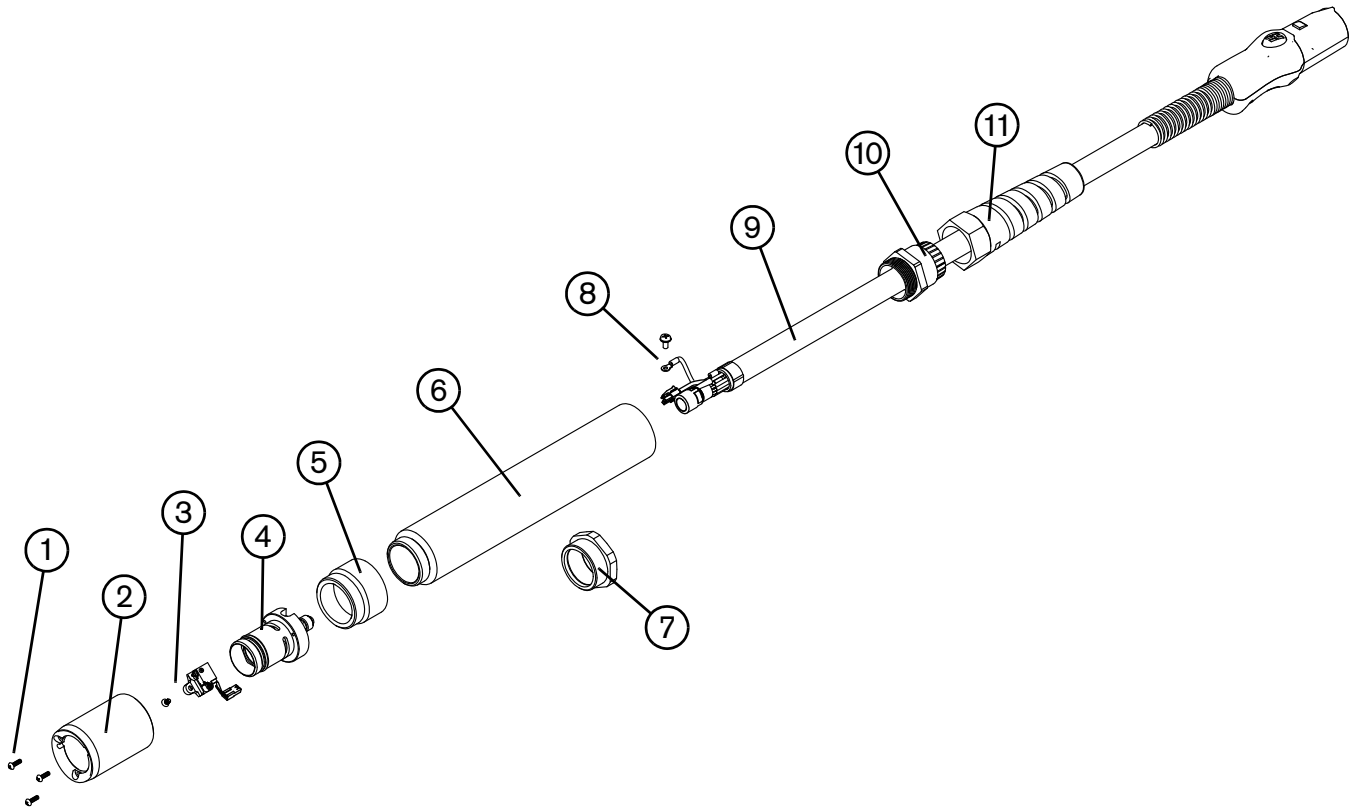

- | | | | |
|---|---|----|-----------------------------------|
| 1 | Mounting sleeve screws | 7 | Adapter (mini machine torch only) |
| 2 | Mounting sleeve | 8 | Pilot arc wire and screw |
| 3 | Cap-sensor switch and screw | 9 | Torch lead |
| 4 | Torch body | 10 | Strain relief |
| 5 | Coupler | 11 | Strain relief nut |
| 6 | Positioning sleeve (full-length machine torch only) | | |



While disconnecting and reconnecting the torch parts, maintain the same orientation between the torch head and torch lead. Twisting the torch head in relation to the torch lead can cause damage to the torch wires.

1. Disconnect the torch lead from the power supply, and remove the consumables from the torch.
2. Unscrew the strain relief nut from the strain relief, and slide the nut back along the torch lead.
3. If you are disassembling the full-length machine torch, unscrew the strain relief from the positioning sleeve. If you are disassembling the mini machine torch, unscrew the strain relief from the adapter. Slide the strain relief back along the torch lead.

6 – Machine Torch Setup

4. If you are disassembling the full-length machine torch, unscrew the positioning sleeve from the coupler. If you are disassembling the mini machine torch, unscrew the adapter from the coupler.
5. Unscrew the coupler from the mounting sleeve.
6. Remove the three screws from the consumables end of the mounting sleeve, and slide the mounting sleeve off the front of the torch body.
7. Disconnect the wire connector for the cap-sensor switch.

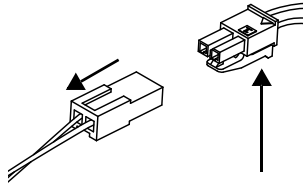

8. Remove the screw that secures the torch's pilot wire to the torch body.

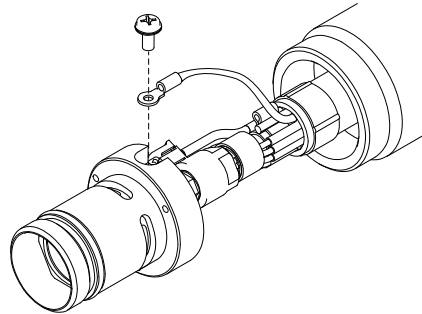

9. Use 5/16-inch and 1/2-inch wrenches, or adjustable wrenches, to loosen the nut that secures the gas supply line to the torch lead. Set the torch body aside.

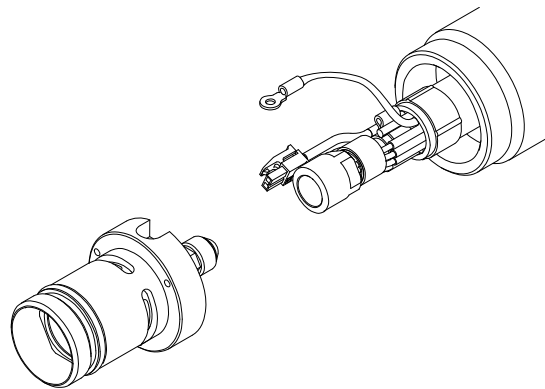

10. Slide the coupler off the front of the torch lead.
11. If you are disassembling a full-length machine torch, slide the positioning sleeve off the front of the torch lead. If you are disassembling a mini machine torch, slide the adapter off the front of the torch lead.

Convert a full-length machine torch to a mini machine torch

You will need the mini machine torch adapter kit (428146) to complete the following procedure. This kit enables you to convert a full-length machine torch to a mini machine torch by removing the positioning sleeve and installing a small adapter ring in its place.



If you are converting a full-length machine torch to a mini machine torch and mounting the torch at the same time, skip this procedure and follow the instructions in *Mount the torch* on page 68.

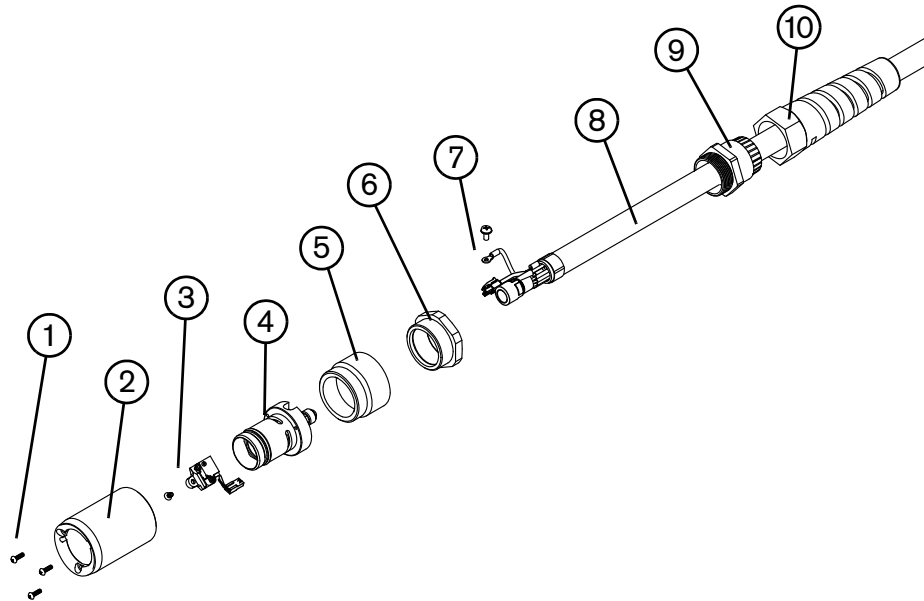

- | | | | |
|---|-----------------------------|----|--------------------------|
| 1 | Mounting sleeve screws | 6 | Adapter (428146) |
| 2 | Mounting sleeve | 7 | Pilot arc wire and screw |
| 3 | Cap-sensor switch and screw | 8 | Torch lead |
| 4 | Torch body | 9 | Strain relief |
| 5 | Coupler | 10 | Strain relief nut |

1. Follow the instructions in *Disassemble the machine torch* on page 65.
2. Slide the adapter over the torch lead.
3. Slide the coupler over the torch lead.
4. Screw the adapter onto the coupler.
5. Reconnect the gas supply line to the torch lead.
6. Reattach the torch's pilot wire to the torch body using the screw.
7. Reconnect the cap-sensor switch's wire connector.

6 – Machine Torch Setup

8. Slide the mounting sleeve over the front of the torch body. Align the slot on the front of the mounting sleeve (next to one of the three screw holes) with the cap-sensor plunger on the torch body.
9. Attach the mounting sleeve to the torch body using the three screws.
10. Screw the coupler onto the mounting sleeve.
11. Screw the strain relief onto the adapter.
12. Screw the strain relief nut onto the strain relief.
13. Reinstall the consumables in the torch, and reconnect the torch lead to the power supply.

Mount the torch

The machine torches can be mounted on a wide variety of X-Y tables, track burners, pipe bevelers, and other equipment. Install the torch per the manufacturer's instructions. Use the following procedure to disassemble and reassemble the torch if you need to do so in order to route the torch through the cutting table's track or other mounting system.

If your cutting table's track is large enough for you to route the torch through it without removing the torch body from the lead, do so and then attach the torch to the lifter per the manufacturer's instructions.



While disconnecting and reconnecting the torch parts, maintain the same orientation between the torch head and torch lead. Twisting the torch head in relation to the torch lead can cause damage to the torch wires.

1. Follow the instructions in *Disassemble the machine torch* on page 65.
-
- 
- Cover the end of the gas line on the torch lead with tape to keep dirt and other contaminants from getting in the gas line when you route the lead through the track.
2. Route the torch lead through the mounting system for the cutting table. Slide the strain relief and strain relief nut along the torch lead as needed to move them out of the way as you route the torch lead through the track.
 3. If you are mounting a full-length machine torch, slide the positioning sleeve over the torch lead. If you are mounting a mini machine torch, slide the adapter over the torch lead.
 4. Slide the coupler over the torch lead.
 5. Reconnect the gas supply line to the torch lead.
 6. Reattach the torch's pilot wire to the torch body using the screw.
 7. Reconnect the cap-sensor switch's wire connector.
 8. Slide the mounting sleeve over the front of the torch body. Align the slot on the front of the mounting sleeve (next to one of the three screw holes) with the cap-sensor plunger on the torch body.
 9. Attach the mounting sleeve to the torch body using the three screws.
 10. Screw the coupler into the mounting sleeve.

11. If you are mounting a full-length machine torch, screw the positioning sleeve into the coupler. If you are mounting a mini machine torch, screw the adapter into the coupler.
12. Screw the strain relief into the positioning sleeve (for a full-length machine torch) or the adapter (for a mini machine torch).
13. Screw the strain relief nut into the strain relief.
14. Attach the torch to the lifter per the manufacturer's instructions.
15. Reinstall the consumables in the torch.

Choose the machine torch consumables

Systems with the Duramax Hyamp 180° full-length machine torch or Duramax Hyamp 180° mini machine torch ship with a starter consumable kit as well as a box of spare electrodes and nozzles. There are two starter mechanized consumable kits. One includes the standard retaining cap, and one includes the ohmic retaining cap. Notice that the retaining cap, electrode, and swirl ring are the same for cutting, gouging, and FineCut applications. Only the shield and nozzle are different.

Both styles of machine torches use the same consumables. Mechanized consumables are shielded. Therefore, if the torch touches the workpiece it will not damage the nozzle.

Machine torch consumables

Mechanized shielded 105 A/125 A consumables

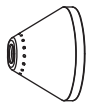

220976
Shield

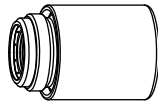

220977
Retaining cap



220975
Nozzle

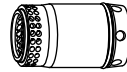

220997
Swirl ring

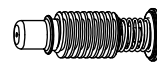

220971
Electrode

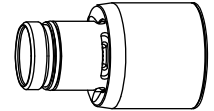

Mechanized shielded 45 A and 65 A consumables

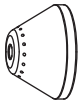

420168
Shield

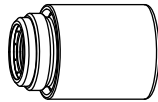

220977
Retaining cap



420158 (45 A)
420169 (65 A)
Nozzle

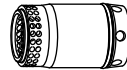

220997
Swirl ring

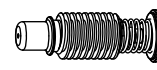

220971
Electrode

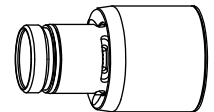

Mechanized shielded with ohmic 105 A/125 A consumables

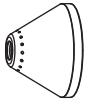

220976
Shield

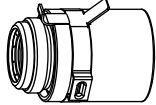

420156
Ohmic-sensing
retaining cap



220975
Nozzle

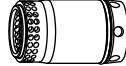

220997
Swirl ring

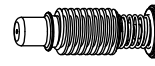

220971
Electrode

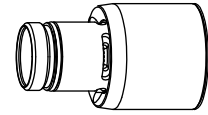

Mechanized shielded with ohmic 45 A and 65 A consumables

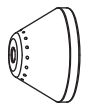

420168
Shield

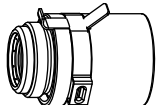

420156
Ohmic-sensing
retaining cap



420158 (45 A)
420169 (65 A)
Nozzle

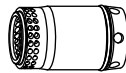

220997
Swirl ring

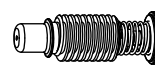

220971
Electrode

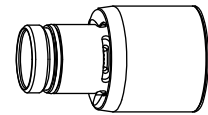

Gouging consumables

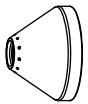

420112
Shield

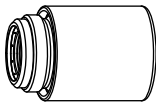

220977
Retaining cap



420001
Nozzle

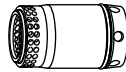

220997
Swirl ring

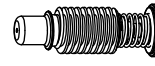

220971
Electrode

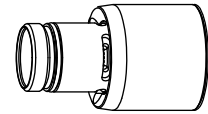

FineCut shielded consumables

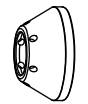

420152
Shield

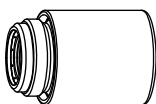

220977
Retaining cap



420151
Nozzle

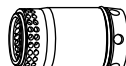

220997
Swirl ring

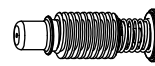

220971
Electrode

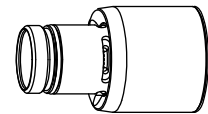

FineCut shielded with ohmic consumables



Install the machine torch consumables

		<p>WARNING!</p> <p>INSTANT-ON TORCHES</p> <p>PLASMA ARC CAN CAUSE INJURY AND BURNS</p>
	<p>The plasma arc comes on immediately when the torch trigger is activated. Make sure the power is OFF before changing consumables.</p>	

To operate the machine torch, a complete set of consumable parts must be installed: shield, retaining cap, nozzle, electrode, and swirl ring.

With the power switch in the OFF (O) position, install the machine torch consumables in a manner similar to the hand torch consumables. See *Hand Torch Setup* on page 47.

Aligning the torch

Mount the machine torch perpendicular to the workpiece in order to get a vertical cut. Use a square to align the torch at right angles to the workpiece.

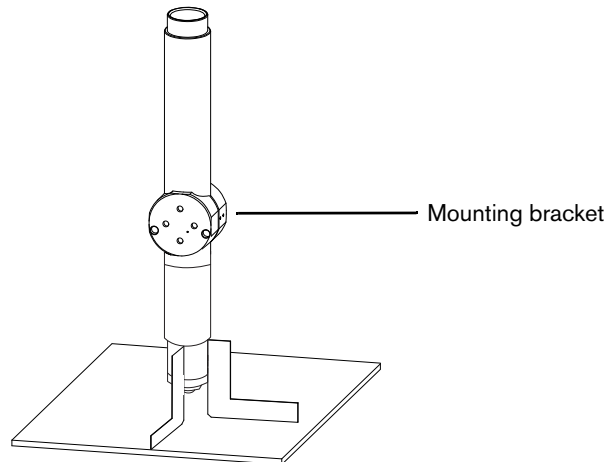

 Position the mounting bracket as low on the torch as possible to minimize vibration at the tip of the torch.

Connecting the torch lead

This system is equipped with FastConnect, a quick-disconnect system for connecting and disconnecting handheld and machine torch leads. When connecting or disconnecting a torch, first turn OFF the system. To connect the torch, push the connector into the receptacle on the front of the power supply.

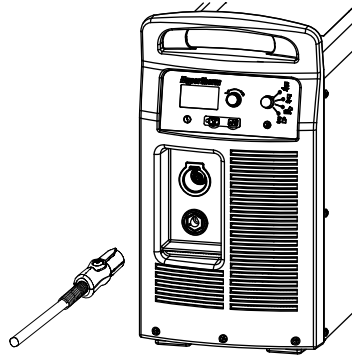

To remove the torch, press the red button on the connector and pull the connector out of the receptacle.

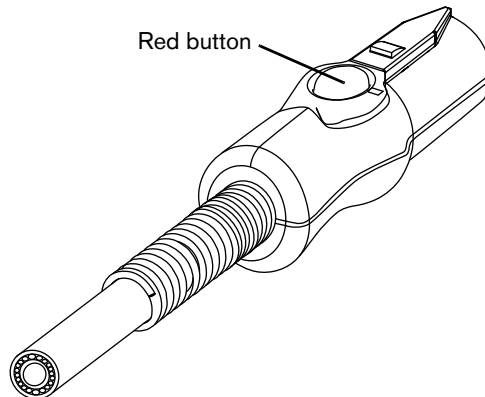

Using the cut charts

The following tables provide cut charts for each set of mechanized consumables. For each consumable type, there are metric and English charts for mild steel, stainless steel, and aluminum. A consumable diagram with part numbers precedes each set of cut charts.

Each cut chart contains the following information:

- **Amperage setting** – The amperage setting at the top left side of the page applies to all the settings given on that page. In FineCut charts, the amperage setting for each thickness is included in the cut chart.
- **Material Thickness** – Thickness of the workpiece (metal plate being cut).
- **Torch-to-Work Distance** – Distance between the shield and the workpiece during cutting. This may also be known as cut height.
- **Initial Pierce Height** – Distance between the shield and the workpiece when the torch is triggered, prior to descending to the cut height.
- **Pierce Delay Time** – Length of time the triggered torch remains stationary at the pierce height before the torch starts the cutting motion.
- **Best Quality Settings** (cut speed and voltage) – Settings that provide the starting point for finding the best cut quality (best angle, least dross, best cut-surface finish). Adjust the speed for your application and table to obtain the desired result.
- **Production Settings** (cut speed and voltage) – 70% to 80% of the maximum speed ratings. These speeds result in the greatest number of cut parts, but not necessarily the best possible cut quality.



The arc voltage increases as the consumables wear, so the voltage setting may need to be increased to maintain the correct torch-to-work distance. Some CNCs monitor the arc voltage and adjust the torch lifter automatically.

Each cut chart lists hot and cold air flow rates.

- **Hot air flow rate** – Plasma is on, the system is operating at running current, and the system is in a steady state at the default system pressure (automatic mode).
- **Cold air flow rate** – Plasma is off and the system is in a steady state with air flowing through the torch at the default system pressure.



Hypertherm collected the cut chart data under laboratory test conditions using new consumables.

Estimated kerf-width compensation

The widths in the following tables are for reference. The data are obtained with the “Best Quality” settings. Differences between installations and material composition may cause actual results to vary from those shown in the tables.

Estimated kerf-width compensation – Metric (mm)

Process	Thickness (mm)														
	0.5	1	2	3	6	8	10	12	16	20	25	30	32	35	40
Mild steel															
125 A shielded					2.2	2.3	2.4	2.4	2.6	2.8	3.1	3.6	3.8	3.9	4.1
105 A shielded					2	2.1	2.2	2.3	2.4	2.5	2.7	3	3.2		
65 A shielded			1.6	1.6	1.8	1.9	2.0	2.2	2.7	3.2	3.7				
45 A shielded	1.6	1.4	1.3	1.5	1.6										
FineCut	1.3	1.2	1.2	1.2											
Stainless steel															
125 A shielded					1.9	2.2	2.4	2.6	2.6	2.7	3.1	3	3	3.2	3.6
105 A shielded					1.6	1.9	2.2	2.3	2.4	2.5	2.9	2.9	2.9		
65 A shielded			1.4	1.5	1.8	1.8	1.9	1.9	2.1	2.3					
45 A shielded	1.4	1.2	1.2	1.5	1.7										
FineCut	1.2	1.2	1.0	1.0											
Aluminum															
125 A shielded					2.3	2.5	2.6	2.6	2.8	2.9	2.8	2.9	3	3.3	3.7
105 A shielded					1.9	2.0	2.2	2.2	2.1	2.1	2.5	2.5	2.5		
65 A shielded			1.9	1.9	1.9	1.9	2.0	2.0	2.1	2.2					
45 A shielded		1.5	1.4	1.6	1.8										

Estimated kerf-width compensation – English (inches)

Process	Thickness (inches)													
	22 GA	18 GA	14 GA	10 GA	3/16	1/4	3/8	1/2	5/8	3/4	7/8	1	1-1/4	1-1/2
Mild steel														
125 A shielded						0.089	0.094	0.095	0.103	0.108	0.109	0.123	0.150	0.158
105 A shielded						0.080	0.088	0.091	0.094	0.099	0.103	0.107	0.125	
65 A shielded			0.062	0.065	0.067	0.070	0.079	0.088	0.104	0.120	0.134	0.147		
45 A shielded	0.062	0.048	0.052	0.061	0.062	0.064								
FineCut	0.049	0.047	0.048	0.048										
Stainless steel														
125 A shielded						0.078	0.094	0.103	0.103	0.103	0.112	0.123	0.116	0.137
105 A shielded						0.067	0.085	0.091	0.094	0.093	0.111	0.116	0.116	
65 A shielded			0.054	0.060	0.065	0.071	0.074	0.076	0.083	0.090				
45 A shielded	0.056	0.042	0.048	0.062	0.065	0.068								
FineCut	0.045	0.044	0.039	0.042										
Aluminum														
		1/32	1/16	1/8	1/4	3/8	1/2	5/8	3/4	7/8	1	1-1/4	1-1/2	
125 A shielded					0.091	0.103	0.104	0.110	0.119	0.101	0.112	0.116	0.140	
105 A shielded					0.075	0.086	0.085	0.083	0.083	0.087	0.101	0.100		
65 A shielded			0.074	0.074	0.075	0.077	0.079	0.082	0.085					
45 A shielded		0.060	0.052	0.062	0.070									

125 A shielded consumables

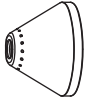

220976
Shield

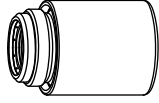

220977
Retaining cap



220975
Nozzle

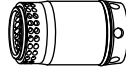

220997
Swirl ring

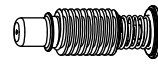

220971
Electrode

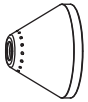
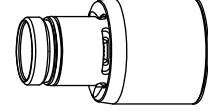

220976
Shield

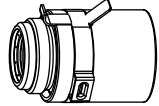

420156
Ohmic-sensing
retaining cap



220975
Nozzle

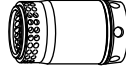

220997
Swirl ring

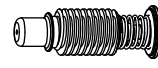

220971
Electrode

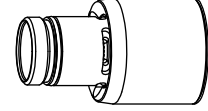

125 A shielded cutting – mild steel

Air flow rate – slpm/scfh	
Hot	260 / 550
Cold	345 / 730

Metric

Material Thickness	Torch-to-Work Distance	Initial Pierce Height		Pierce Delay Time	Best Quality Settings		Production Settings		
					Cut Speed	Voltage	Cut Speed	Voltage	
mm	mm	mm	%	seconds	mm/min	volts	mm/min	volts	
6	4.6	9.2	200	0.2	4980	158	5960	155	
8				0.3	3800	158	4570	157	
10				0.4	2750	158	3330	158	
12				0.5	2050	157	2510	157	
16		11.5	250	0.6	1260	162	1660	164	
20				2.0	980	165	1140	164	
25				3.5	610	169	780	167	
30		Edge Start*			1.0	460	169	580	167
32						400	174	500	172
35						340	177	430	175
40	240					180	310	178	

English

Material Thickness	Torch-to-Work Distance	Initial Pierce Height		Pierce Delay Time	Best Quality Settings		Production Settings		
					Cut Speed	Voltage	Cut Speed	Voltage	
inches	inches	inches	%	seconds	ipm	volts	ipm	volts	
1/4	0.18	0.36	200	0.2	188	158	225	155	
3/8				0.4	114	158	138	158	
1/2				0.5	75	158	93	158	
5/8		0.45	250	0.6	50	162	66	164	
3/4				0.8	42	164	48	163	
7/8				2.0	31	168	37	166	
1				3.5	23	169	30	167	
1-1/4		Edge Start*			1.0	16	174	20	172
1-1/2						11	179	14	177

* You can pierce thicknesses up to 32 mm (1-1/4 inch) if your CNC software and torch height control system enable you to temporarily raise the torch in order to clear the puddle of dross that can form during the pierce. In Hypertherm's Phoenix CNC software, for example, this function is referred to as the "puddle jump height." Using this piercing function may affect consumable life.

6 – Machine Torch Setup

125 A shielded cutting – stainless steel

Air flow rate – slpm/scfh	
Hot	260 / 550
Cold	345 / 730

Metric

Material Thickness	Torch-to-Work Distance	Initial Pierce Height		Pierce Delay Time	Best Quality Settings		Production Settings	
					Cut Speed	Voltage	Cut Speed	Voltage
mm	mm	mm	%	seconds	mm/min	volts	mm/min	volts
6	4.6	9.2	200	0.5	5910	156	7690	157
8					4060	157	5550	157
10					2540	159	3700	157
12					2170	163	2710	157
16		11.5	250	0.7	1140	165	1460	162
20				1.2	940	167	1030	163
25		Edge Start		1.0	540	172	760	166
30					430	173	640	166
32				1.1	400	177	600	169
35				1.2	320	180	450	173
40					180	185	210	179

English

Material Thickness	Torch-to-Work Distance	Initial Pierce Height		Pierce Delay Time	Best Quality Settings		Production Settings	
					Cut Speed	Voltage	Cut Speed	Voltage
inches	inches	inches	%	seconds	ipm	volts	ipm	volts
1/4	0.18	0.36	200	0.5	220	156	288	157
3/8					104	158	154	157
1/2					78	163	98	158
5/8		0.45	250	0.7	45	165	58	162
3/4				1.2	40	167	43	163
7/8		Edge Start		0.8	30	168	35	164
1				1.0	20	173	29	166
1-1/4				1.1	16	177	24	169
1-1/2				1.2	9	183	12	177

125 A shielded cutting – aluminum

Air flow rate – slpm/scfh	
Hot	260 / 550
Cold	345 / 730

Metric

Material Thickness	Torch-to-Work Distance	Initial Pierce Height		Pierce Delay Time	Best Quality Settings		Production Settings		
					Cut Speed	Voltage	Cut Speed	Voltage	
mm	mm	mm	%	seconds	mm/min	volts	mm/min	volts	
6	4.6	9.2	200	0.2	7660	159	8560	156	
8				0.3	5100	161	6100	157	
10				0.4	2980	163	4020	159	
12				0.5	2140	+++++++ +++++++ +++++++ +++++++1 65	3070	162	
16		11.5	250	0.6	1540	169	2090	163	
20				2.0	1260	170	1500	167	
25				3.5	850	174	1050	167	
30		Edge Start			1.0	540	175	830	167
32					1.1	430	182	750	174
35					1.2	370	183	580	176
40						270	185	300	179

English

Material Thickness	Torch-to-Work Distance	Initial Pierce Height		Pierce Delay Time	Best Quality Settings		Production Settings		
					Cut Speed	Voltage	Cut Speed	Voltage	
inches	inches	inches	%	seconds	ipm	volts	ipm	volts	
1/4	0.18	0.36	200	0.2	284	159	320	156	
3/8				0.4	124	163	166	158	
1/2				0.5	80	166	114	162	
5/8		0.45	250	0.6	61	169	83	163	
3/4				0.8	52	170	62	167	
7/8				2.0	44	171	52	167	
1				3.5	32	175	40	167	
1-1/4		Edge Start			1.0	17	182	30	174
1-1/2						12	184	16	178

105 A shielded consumables

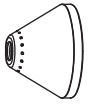

220976
Shield

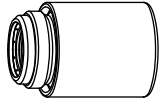

220977
Retaining cap



220975
Nozzle

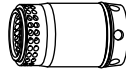

220997
Swirl ring

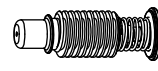

220971
Electrode

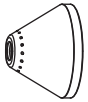
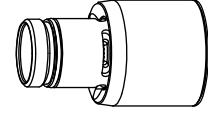

220976
Shield

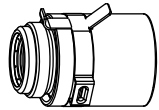

420156
Ohmic-sensing
retaining cap



220975
Nozzle

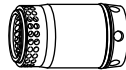

220997
Swirl ring

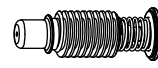

220971
Electrode

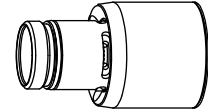

105 A shielded cutting – mild steel

Air flow rate – slpm/scfh	
Hot	283 / 600
Cold	345 / 730

Metric

Material Thickness	Torch-to-Work Distance	Initial Pierce Height		Pierce Delay Time	Best Quality Settings		Production Settings	
					Cut Speed	Voltage	Cut Speed	Voltage
mm	mm	mm	%	seconds	mm/min	volts	mm/min	volts
6	4.6	9.2	200	0.5	4110	158	4920	146
8				0.6	3220	158	3770	150
10				0.8	2410	159	2730	153
12				0.7	1810	163	1980	156
16		11.5	250	1.0	1050	165	1230	155
20				1.3	780	168	850	157
25		Edge Start		1.0	540	174	580	162
30					420	176	440	168
32				1.2	370	177	400	170

English

Material Thickness	Torch-to-Work Distance	Initial Pierce Height		Pierce Delay Time	Best Quality Settings		Production Settings	
					Cut Speed	Voltage	Cut Speed	Voltage
inches	inches	inches	%	seconds	ipm	volts	ipm	volts
1/4	0.18	0.36	200	0.5	156	158	186	147
3/8				0.75	100	158	114	152
1/2				0.75	66	163	73	156
5/8		0.45	250	1.0	42	165	49	155
3/4				1.0	33	168	35	156
7/8				2.0	26	169	30	158
1				Edge Start		1.0	21	175
1-1/4		1.2	15			177	16	170

6 – Machine Torch Setup

105 A shielded cutting – stainless steel

Air flow rate – slpm/scfh	
Hot	283 / 600
Cold	345 / 730

Metric

Material Thickness	Torch-to-Work Distance	Initial Pierce Height		Pierce Delay Time	Best Quality Settings		Production Settings	
					Cut Speed	Voltage	Cut Speed	Voltage
mm	mm	mm	%	seconds	mm/min	volts	mm/min	volts
6	4.6	9.2	200	0.5	5320	158	5780	144
8					3650	159	3940	148
10					2230	160	2420	151
12					1490	162	1960	154
16		11.5	250	1.0	950	166	1050	156
20				2.5	660	169	730	158
25		Edge Start		1.0	440	174	520	162
30					330	176	450	167
32				1.2	290	177	420	169

English

Material Thickness	Torch-to-Work Distance	Initial Pierce Height		Pierce Delay Time	Best Quality Settings		Production Settings	
					Cut Speed	Voltage	Cut Speed	Voltage
inches	inches	inches	%	seconds	ipm	volts	ipm	volts
1/4	0.18	0.36	200	0.5	198	158	215	145
3/8					94	160	100	150
1/2					55	163	71	154
5/8		0.45	250	1.0	38	166	42	156
3/4				2.5	28	168	30	157
7/8		Edge Start		1.0	22	172	26	159
1					17	174	20	163
1-1/4				1.2	12	177	17	169

105 A shielded cutting – aluminum

Air flow rate – slpm/scfh	
Hot	283 / 600
Cold	345 / 730

Metric

Material Thickness	Torch-to-Work Distance	Initial Pierce Height		Pierce Delay Time	Best Quality Settings		Production Settings	
					Cut Speed	Voltage	Cut Speed	Voltage
mm	mm	mm	%	seconds	mm/min	volts	mm/min	volts
6	4.6	9.2	200	0.5	6340	158	6390	154
8				0.6	4330	162	4690	154
10				0.8	2660	164	3250	155
12				0.7	2020	167	2590	159
16		11.5	250	1.0	1350	169	1550	157
20				1.3	970	172	1020	161
25		Edge Start		1.0	660	176	800	167
30					460	180	580	174
32				1.2	390	182	490	176

English

Material Thickness	Torch-to-Work Distance	Initial Pierce Height		Pierce Delay Time	Best Quality Settings		Production Settings	
					Cut Speed	Voltage	Cut Speed	Voltage
inches	inches	inches	%	seconds	ipm	volts	ipm	volts
1/4	0.18	0.36	200	0.5	236	159	240	154
3/8				0.75	110	164	134	154
1/2					75	167	95	159
5/8		0.45	250	1.0	54	169	62	157
3/4					40	171	42	160
7/8				2.0	34	173	37	164
1					1.0	25	176	31
1-1/4		Edge Start		1.2	16	182	20	176

65 A shielded consumables



420168
Shield

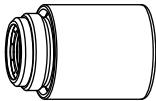

220977
Retaining cap



420169
Nozzle

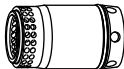

220997
Swirl ring

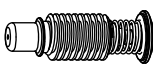

220971
Electrode

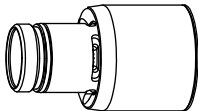

420168
Shield

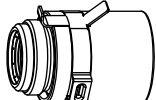

420156
Ohmic-sensing
retaining cap



420169
Nozzle

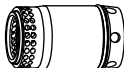

220997
Swirl ring

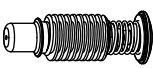

220971
Electrode

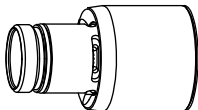

65 A shielded cutting – mild steel

Air flow rate – slpm/scfh	
Hot	222 / 470
Cold	250 / 530

Metric

Material Thickness	Torch-to-Work Distance	Initial Pierce Height		Pierce Delay Time	Best Quality Settings		Production Settings		
					Cut Speed	Voltage	Cut Speed	Voltage	
mm	mm	mm	%	seconds	mm/min	volts	mm/min	volts	
2	1.5	3.8	250	0.1	5930	122	7015	123	
3				0.2	5150	123	6080	123	
4				0.5	4370	123	5145	123	
6					2815	125	3275	124	
8					1815	127	2235	126	
10		4.5	300	0.7	1085	129	1490	128	
12				1.2	845	131	1140	130	
16		6	400	2.0	565	136	740	135	
20		Edge start				355	141	450	140
25		Edge start				215	146	270	146

English

Material Thickness	Torch-to-Work Distance	Initial Pierce Height		Pierce Delay Time	Best Quality Settings		Production Settings		
					Cut Speed	Voltage	Cut Speed	Voltage	
inches	inches	inches	%	seconds	ipm	volts	ipm	volts	
16 GA	0.06	0.15	250	0.1	248	122	294	122	
10 GA					190	123	224	123	
3/16				0.2	149	124	174	123	
1/4				0.5	100	125	116	124	
3/8					0.7	45	129	62	128
1/2		0.18	300		1.2	30	132	40	131
5/8		0.24	400	2.0	23	136	30	135	
3/4		Edge Start				15	140	19	139
7/8		Edge Start				12	143	15	143
1		Edge Start				8	146	10	146

6 – Machine Torch Setup

65 A shielded cutting – stainless steel

Air flow rate – slpm/scfh	
Hot	222 / 470
Cold	250 / 530

Metric

Material Thickness	Torch-to-Work Distance	Initial Pierce Height		Pierce Delay Time	Best Quality Settings		Production Settings	
					Cut Speed	Voltage	Cut Speed	Voltage
mm	mm	mm	%	seconds	mm/min	volts	mm/min	volts
2	1.5	3.8	250	0.1	7405	119	9970	121
3				0.2	6120	120	8240	122
4				0.5	4840	122	6110	123
6					2275	125	2840	125
8				0.7	1505	127	1860	127
10		1115	130		1245	128		
12		720	133		925	130		
16		Edge Start			465	137	505	136
20		Edge Start			320	141	345	141

English

Material Thickness	Torch-to-Work Distance	Initial Pierce Height		Pierce Delay Time	Best Quality Settings		Production Settings		
					Cut Speed	Voltage	Cut Speed	Voltage	
inches	inches	inches	%	seconds	ipm	volts	ipm	volts	
16 GA	0.06	0.15	250	0.1	316	118	425	120	
10 GA					220	121	296	122	
3/16				0.2	152	123	168	123	
1/4					0.5	72	125	96	125
3/8						48	130	52	128
1/2		0.18	300	1.2	23	134	32	131	
5/8					Edge Start			19	137
3/4		Edge Start			14	140	15	140	

65 A shielded cutting – aluminum

Air flow rate – slpm/scfh	
Hot	222 / 470
Cold	250 / 530

Metric

Material Thickness	Torch-to-Work Distance	Initial Pierce Height		Pierce Delay Time	Best Quality Settings		Production Settings	
					Cut Speed	Voltage	Cut Speed	Voltage
mm	mm	mm	%	seconds	mm/min	volts	mm/min	volts
2	1.5	3.8	250	0.1	7805	123	10265	122
3				0.2	6565	125	8790	123
4				0.5	5320	126	7320	124
6					2845	129	4375	126
8				0.7	2015	133	2750	129
10		1535	136		1650	132		
12		1055	139		1330	135		
16		Edge Start			640	143	805	140
20					335	146	550	144

English

Material Thickness	Torch-to-Work Distance	Initial Pierce Height		Pierce Delay Time	Best Quality Settings		Production Settings	
					Cut Speed	Voltage	Cut Speed	Voltage
inches	inches	inches	%	seconds	ipm	volts	ipm	volts
1/16	0.06	0.15	250	0.1	328	123	428	122
1/8					250	125	336	123
1/4				0.5	95	130	152	126
3/8					65	135	68	131
1/2		0.18	300	1.2	35	140	48	136
5/8		Edge Start			26	143	32	140
3/4					16	145	24	143

45 A shielded consumables



420168
Shield

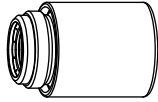

220977
Retaining cap



420158
Nozzle

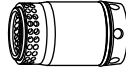

220997
Swirl ring

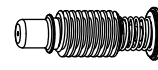

220971
Electrode

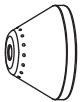
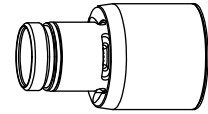

420168
Shield

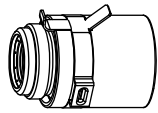

420156
Ohmic-sensing
retaining cap



420158
Nozzle

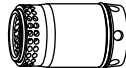

220997
Swirl ring

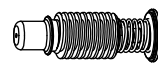

220971
Electrode

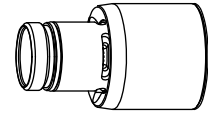

45 A shielded cutting – mild steel

Air flow rate – slpm/scfh	
Hot	217 / 460
Cold	241 / 510

Metric

Material Thickness	Torch-to-Work Distance	Initial Pierce Height		Pierce Delay Time	Best Quality Settings		Production Settings	
					Cut Speed	Voltage	Cut Speed	Voltage
mm	mm	mm	%	seconds	mm/min	volts	mm/min	volts
0.5	0.5	2.0	400	0.0	8890	118	12510	120
1				0.1	8890	119	10760	120
1.5				0.3	8040	123	10160	123
2	1.5	3.8	250	0.4	6565	128	7770	125
3				0.5	3725	129	4890	128
4				0.4	2250	130	3550	130
6				0.5	1265	132	2050	130

English

Material Thickness	Torch-to-Work Distance	Initial Pierce Height		Pierce Delay Time	Best Quality Settings		Production Settings	
					Cut Speed	Voltage	Cut Speed	Voltage
inches	inches	inches	%	seconds	ipm	volts	ipm	volts
26 GA	0.02	0.08	400	0.0	350	118	500	120
22 GA				0.1	350	118	450	120
18 GA				0.1	350	119	400	120
16 GA	0.06	0.15	250	0.1	314	123	400	123
14 GA				0.2	270	128	320	125
12 GA				0.4	185	129	216	127
10 GA				0.4	100	130	164	130
3/16				0.5	74	131	108	130
1/4				0.6	43	132	73	130

6 – Machine Torch Setup

45 A shielded cutting – stainless steel

Air flow rate – slpm/scfh	
Hot	217 / 460
Cold	241 / 510

Metric

Material Thickness	Torch-to-Work Distance	Initial Pierce Height		Pierce Delay Time	Best Quality Settings		Production Settings		
					Cut Speed	Voltage	Cut Speed	Voltage	
mm	mm	mm	%	seconds	mm/min	volts	mm/min	volts	
0.5	0.5	2.0	400	0.0	8890	113	12510	120	
1					8890	113	10760	120	
1.5					7825	117	10160	120	
2	1.5	3.8	250	0.3	6095	122	8615	122	
3					0.4	3585	123	4405	123
4						2185	126	2810	126
6						975	132	1140	132

English

Material Thickness	Torch-to-Work Distance	Initial Pierce Height		Pierce Delay Time	Best Quality Settings		Production Settings		
					Cut Speed	Voltage	Cut Speed	Voltage	
inches	inches	inches	%	seconds	ipm	volts	ipm	volts	
26 GA	0.02	0.08	400	0.0	350	113	500	120	
22 GA					350	113	450	120	
18 GA					0.1	350	113	400	120
16 GA	305	117	400	120					
14 GA	0.06	0.15	250	0.2	250	122	360	122	
12 GA					0.4	175	123	206	123
10 GA						100	124	134	124
3/16					0.5	68	128	80	128
1/4						30	133	35	133

45 A shielded cutting – aluminum

Air flow rate – slpm/scfh	
Hot	217 / 460
Cold	241 / 510

Metric

Material Thickness	Torch-to-Work Distance	Initial Pierce Height		Pierce Delay Time	Best Quality Settings		Production Settings	
					Cut Speed	Voltage	Cut Speed	Voltage
mm	mm	mm	%	seconds	mm/min	volts	mm/min	volts
1	1.5	3.8	250	0.0	9145	126	11100	124
2				0.1	7470	125	9210	124
3				0.2	4675	125	6190	125
4				0.4	3700	129	4845	127
6				0.5	1740	135	2795	132

English

Material Thickness	Torch-to-Work Distance	Initial Pierce Height		Pierce Delay Time	Best Quality Settings		Production Settings	
					Cut Speed	Voltage	Cut Speed	Voltage
inches	inches	inches	%	seconds	ipm	volts	ipm	volts
1/32	0.06	0.15	250	0.0	360	126	450	124
1/16				0.1	360	126	400	124
3/32				0.2	233	124	328	124
1/8				0.4	177	126	224	125
1/4				0.5	55	136	96	133

FineCut consumables



420152
Shield

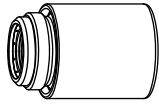

220977
Retaining cap



420151
Nozzle

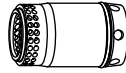

220997
Swirl ring

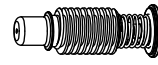

220971
Electrode

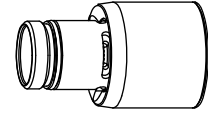

420152
Shield

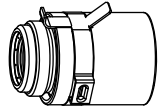

420156
Ohmic-sensing
retaining cap



420151
Nozzle

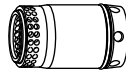

220997
Swirl ring

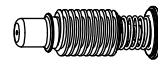

220971
Electrode

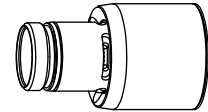

FineCut – mild steel

Air flow rate – slpm/scfh	
Hot	217 / 460
Cold	226 / 480

Metric

Material Thickness	Current	Torch-to-Work Distance	Initial Pierce Height		Pierce Delay Time	Recommended	
						Cut Speed	Voltage
mm	A	mm	mm	%	seconds	mm/min	volts
0.5	30	1.5	2.25	150	0.0	4330	83
0.6						4080	85
0.8						4065	85
1	40				0.2	4825	81
1.5						0.4	4825
2	45				0.4		4740
3						0.5	3445
4					1270		80

English

Material Thickness	Current	Torch-to-Work Distance	Initial Pierce Height		Pierce Delay Time	Recommended	
						Cut Speed	Voltage
inches	A	inches	inches	%	seconds	ipm	volts
26 GA	30	0.06	0.09	150	0.0	175	82
24 GA						160	85
22 GA						160	85
20 GA	40				0.1	160	85
18 GA						0.2	190
16 GA	45				0.4		190
14 GA						0.5	190
12 GA					0.5		165
10 GA	100	80					

6 – Machine Torch Setup

FineCut – stainless steel

Air flow rate – slpm/scfh	
Hot	217 / 460
Cold	226 / 480

Metric

Material Thickness	Current	Torch-to-Work Distance	Initial Pierce Height		Pierce Delay Time	Recommended	
						Cut Speed	Voltage
mm	A	mm	mm	%	seconds	mm/min	volts
0.5	30	0.51	2.03	400	0.0	4825	77
0.6						4825	77
0.8						4825	73
1	40				0.2	4825	86
1.5						0.4	4825
2	45				4550		72
3					0.5	2335	70
4						995	72

English

Material Thickness	Current	Torch-to-Work Distance	Initial Pierce Height		Pierce Delay Time	Recommended	
						Cut Speed	Voltage
inches	A	inches	inches	%	seconds	ipm	volts
26 GA	30	0.02	0.08	400	0.0	190	77
24 GA						190	77
22 GA						190	74
20 GA	40				0.1	190	72
18 GA						0.2	190
16 GA	45				0.4		190
14 GA						190	72
12 GA					0.5	110	70
10 GA	70	71					

Connecting an optional remote-start pendant

Powermax125 configurations with a Duramax Hyamp machine torch can include an optional remote-start pendant.

- Part number 128650: 7.6 m (25 feet)
- Part number 128651: 15 m (50 feet)
- Part number 128652: 23 m (75 feet)
- Part number 428755: 45.7 m (150 feet)

Remove the machine interface receptacle cover on the rear of the power supply, and plug the Hypertherm remote-start pendant into the receptacle.

 The remote-start pendant is for use only with a machine torch. It will not operate if a handheld torch is installed.

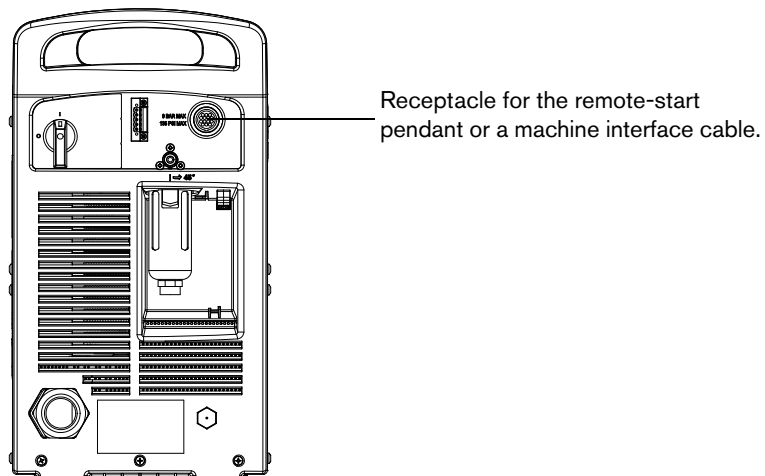

Connecting the machine interface cable

The Powermax125 is equipped with a factory-installed five-position voltage divider board. The built-in voltage divider provides a scaled down arc voltage of 20:1, 21.1:1, 30:1, 40:1, or 50:1 (maximum output of 16 V). A receptacle on the rear of the power supply (see the previous illustration) provides access to the scaled down arc voltage and signals for arc transfer and plasma start.



The factory presets the voltage divider to 50:1. To change the voltage divider to a different setting, refer to *Setting the five-position voltage divider* on page 99.



CAUTION

The factory-installed internal voltage divider provides a maximum of 16 V under open circuit conditions. This is an impedance-protected functional extra low voltage (ELV) output to prevent shock, energy, and fire under normal conditions at the machine interface receptacle and under single fault conditions with the machine interface wiring. The voltage divider is not fault tolerant, and ELV outputs do not comply with safety extra low voltage (SELV) requirements for direct connection to computer products.

Hypertherm offers several choices of machine interface cables:

- To use the built-in voltage divider that provides a scaled down arc voltage in addition to signals for arc transfer and plasma start:
 - Use part number 228350 (7.6 m, 25 feet) or 228351 (15 m, 50 feet) for wires terminated with spade connectors.
 - Use one of the following part numbers for a cable terminated with a D-sub connector. (Compatible with Hypertherm products, such as EDGE® Pro Ti and Sensor™ PHC.)
 - 223354 (3.0 m, 10 feet)
 - 223355 (6.1 m, 20 feet)
 - 223048 (7.6 m, 25 feet)
 - 223356 (10.7 m, 35 feet)
 - 123896 (15 m, 50 feet)
- To use signals for arc transfer and plasma start only, use either part number 023206 (7.6 m, 25 feet) or part number 023279 (15 m, 50 feet). These cables have spade connectors as follows:

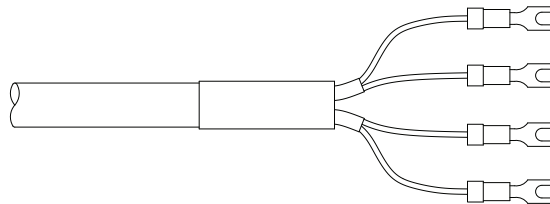

Refer to *Machine interface pinout* on page 98 for receptacle pinout information.



The cover on the machine interface receptacle prevents dust and moisture from damaging the receptacle when not in use. This cover should be replaced if damaged or lost (part number 127204).

Refer to *Parts* on page 119 for more information.

Installation of the machine interface cable must be performed by a qualified service technician. To install a machine interface cable:

1. Turn OFF the power and disconnect the power cord.
2. Remove the machine interface receptacle's cover from the rear of the power supply.
3. Connect the Hypertherm machine interface cable to the power supply.
4. If you are using a cable with a D-sub connector on the other end, plug it into the appropriate pin connector on the torch height controller or CNC. Secure it with the screws on the D-sub connector.

If you are using a cable with wires and spade connectors on the other end, terminate the machine interface cable inside the electrical enclosure of the torch height controller or CNC controller to prevent unauthorized access to the connections after installation. Verify that the connections are correct and that all live parts are enclosed and protected before operating the equipment.



The integration of Hypertherm equipment and customer-supplied equipment including interconnecting cords and cables, if not listed and certified as a system, is subject to inspection by local authorities at the final installation site.

The connector sockets for each type of signal available through the machine interface cable are shown in *Figure 2* on page 98. *Table 11* on page 98 provides details about each signal type.

Machine interface pinout

Figure 2 – Connector sockets

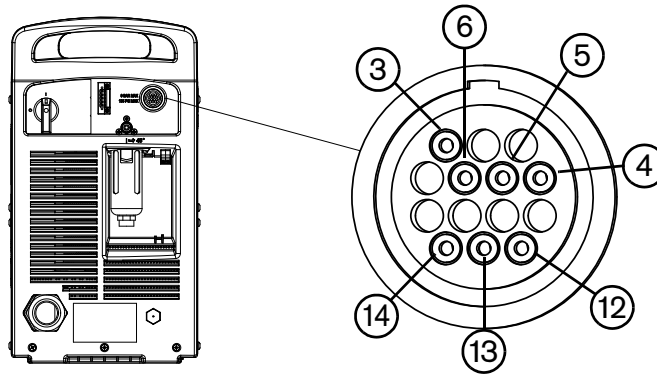

Refer to *Table 11* when connecting the power supply to a torch height controller or CNC controller with a machine interface cable.

Table 11 – Machine interface cable signals

Signal	Type	Notes	Connector sockets	External cable wires
Start (start plasma)	Input	Normally open. 18 VDC open circuit voltage at START terminals. Requires dry contact closure to activate.	3, 4	Green, black
Transfer (start machine motion)	Output	Normally open. Dry contact closure when the arc transfers. 120 VAC/1 A maximum at the machine interface relay.	12, 14	Red, black
Ground	Ground		13	
Voltage divider	Output	Divided arc signal of 20:1, 21.1:1, 30:1, 40:1, 50:1 (provides a maximum of 16 V).	5 (-), 6 (+)	Black (-), white (+)

Setting the five-position voltage divider

To change the factory preset voltage divider from 50:1 to a different setting:

1. Turn OFF the power supply and disconnect the power cord.
2. Remove the power supply cover.
3. Locate the voltage divider DIP switches on the fan side of the power supply.

 Figure 3 shows the default setting (50:1) with the number 4 switch up.

Figure 3 – Voltage divider at default setting (50:1)





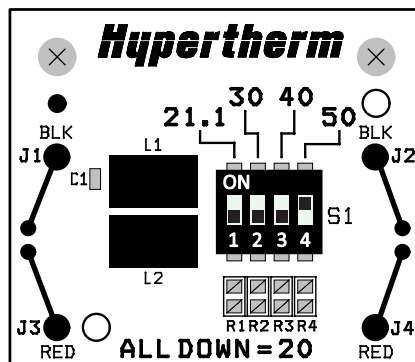
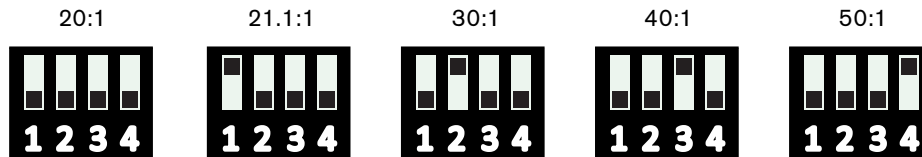

4. Set the DIP switches to one of the following settings, and replace the power supply cover.



If the Hypertherm five-position voltage divider does not supply the required voltage for your application, contact your system integrator for assistance.

Accessing raw arc voltage

To access divided raw arc voltage, refer to Field Service Bulletin 807060.

		WARNING! SHOCK HAZARD, ENERGY HAZARD, AND FIRE HAZARD
		Connecting directly to the plasma circuit for access to raw arc voltage increases the risk of shock hazard, energy hazard, and fire hazard in the event of a single fault. The output voltage and the output current of the circuit are specified on the data plate.

Connecting an optional RS-485 serial interface cable

The RS-485 serial interface connector on the back of the power supply allows you to connect an external device to your Powermax. For example, you can remotely operate the Powermax with a CNC controller.

The Powermax power supply must be equipped with a factory-installed (or user-installed) RS-485 serial interface connector on the rear panel. The receptacle on the rear of the power supply provides access to the RS-485 board inside the power supply.

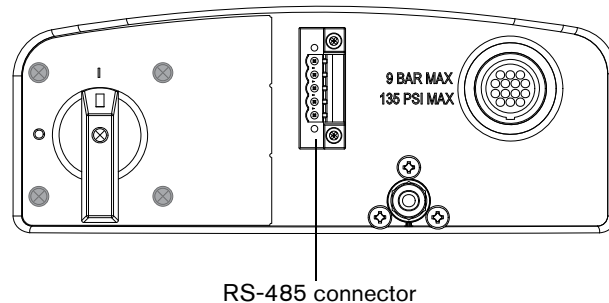

If your power supply is not equipped with the RS-485 connector, order kit 228539, "Powermax65/85/105/125 RS-485 board with cables". Follow the installation instructions in the *Power Supply Component Replacement* section of the Powermax125 Service Manual (808070), which you can download from the Documents Library at www.hypertherm.com.

With the RS-485 connector installed:

1. Shut OFF the power supply.
2. Connect the RS-485 cable from your external device to the receptacle on the back of the Powermax power supply.

Serial port cables

The following serial cables are available with the specified lengths and connectors:

- 223236 – RS-485 cable, unterminated, 7.6 m (25 feet)
- 223237 – RS-485 cable, unterminated, 15 m (50 feet)
- 223239 – RS-485 cable, 9-pin D-sub connector for Hypertherm controls, 7.6 m (25 feet)
- 223240 – RS-485 cable, 9-pin D-sub connector for Hypertherm controls, 15 m (50 feet)

Using the machine torch

Since the Powermax with a machine torch can be used with a wide variety of cutting tables, track burners, pipe bevelers, and so on, you will need to refer to the manufacturer's instructions for specifics on operating the machine torch in your configuration. However, the following topics will help you optimize cut quality and maximize consumable life.

Setting up the torch and table

- Use a square to align the torch at right angles to the workpiece in two dimensions.
- The torch may travel more smoothly if you clean, check, and “tune” the cutting table's rails and drive system. Unsteady machine motion can cause a regular, wavy pattern on the cut surface.
- Ensure that the torch does not touch the workpiece during cutting. Contact with the workpiece can damage the shield and nozzle and affect the cut surface.

Understand and optimize cut quality

Several factors affect cut quality:

- Cut angle – The degree of angularity of the cut edge.
- Dross – The molten material that solidifies on the top or bottom of the workpiece.
- Straightness of the cut surface – The cut surface can be concave or convex.

The following topics explain how these factors can affect cut quality.

Cut or bevel angle

- A positive cut angle results when more material is removed from the top of the cut than from the bottom.
- A negative cut angle results when more material is removed from the bottom of the cut.

Figure 4 – Cut angles

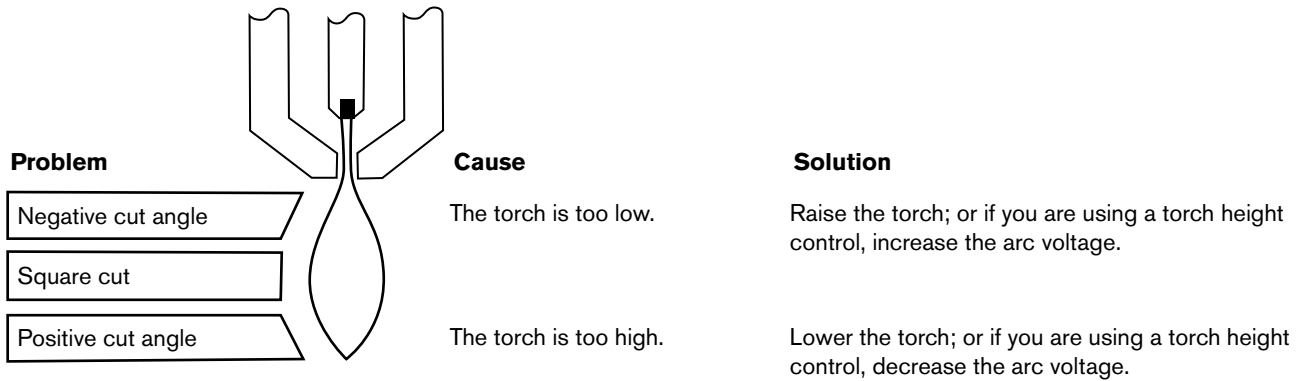

 The squarest cut angle will be on the *right* side with respect to the forward motion of the torch. The left side will always have some degree of cut angle.

To determine whether a cut-angle problem is being caused by the plasma system or the drive system, make a test cut and measure the angle of each side. Next, turn the torch 90° in its holder and repeat the process. If the angles are the same in both tests, the problem is in the drive system.

If a cut-angle problem persists after mechanical causes have been eliminated (see *Setting up the torch and table* on page 101), check the torch-to-work distance, especially if the cut angles are all positive or all negative. Also consider the material being cut: if the metal is magnetized or hardened, you are more likely to experience cut angle problems.

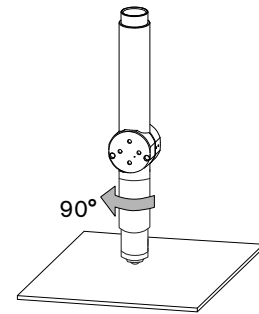

Dross

Some amount of dross will always be present when cutting with air plasma. However, you can minimize the amount and type of dross by adjusting your system correctly for your application.

Excess dross appears on the top edge of both pieces of the plate when the torch is too low (or voltage is too low when using a torch height control). Adjust the torch or adjust the voltage in small increments (5 volts or less) until the dross is reduced.

Low-speed dross forms when the torch's cutting speed is too slow and the arc angles ahead. It forms as a heavy, bubbly deposit at the bottom of the cut and can be removed easily. Increase the speed to reduce this type of dross.

High-speed dross forms when the cutting speed is too fast and the arc angles behind. It forms as a thin, linear bead of solid metal attached very close to the cut. It is more firmly attached to the bottom of the cut than at low speed and is difficult to remove. To reduce high-speed dross:

- Decrease the cutting speed.
- Decrease the torch-to-work distance.

Piercing a workpiece using the machine torch

As with the hand torch, you can start a cut with the machine torch at the edge of the workpiece or by piercing the workpiece. Piercing may result in a shorter consumable life than with edge starts.

The cut charts include a column for the recommended torch height when starting a pierce. For the Powermax125, the pierce height is generally between 1.5 and 4 times the cut height. Refer to the cut charts for specific values.

The pierce delay must be long enough that the arc can pierce the material before the torch moves, but not so long that the arc “wanders” while trying to find the edge of a large hole. As consumables wear, this delay time may need to be increased. Pierce delay times given in the cut charts are based on average delay times throughout the life of the consumables.

When piercing materials close to the maximum thickness for a specific process, consider the following important factors:

- Allow a lead-in distance approximately equal to the thickness of the material being pierced. For example, 20 mm (3/4 in) material requires a 20 mm lead-in.
- To avoid damage to the shield from the buildup of molten material created by the pierce, do not allow the torch to descend to cut height until it has cleared the puddle of molten material.
- Different material chemistries can have an adverse effect on the pierce capability of the system. In particular, high-strength steel with a high manganese or silicon content can reduce the maximum pierce capability. Hypertherm derives mild steel parameters using certified A-36 plate.

Common machine-cutting faults

The torch's pilot arc will initiate, but will not transfer.

- The work lead is not making good contact with the cutting table, or the cutting table is not making good contact with the workpiece.
- The torch-to-work distance/cut height is too large.

The workpiece is not totally pierced, and there is excessive sparking on the top of the workpiece.

- The metal surface is not clean of rust or paint.
- The consumables are worn and need to be replaced. For optimized performance in a mechanized application, replace the nozzle and the electrode together.
- The work lead is not making good contact with the cutting table, or the cutting table is not making good contact with the workpiece.
- The current (amperage) is set too low. See *Machine Torch Setup* on page 63.
- The cut speed is too high. See the cut charts under *Using the cut charts* on page 73.
- The metal being cut exceeds the maximum capacity for the selected amperage. See *Specifications* on page 15.

7 – Mechanized Cutting

Excessive dross forms on the bottom of the cut.

- The gas setting is too high or too low.
- The consumables are worn and need to be replaced. For optimized performance in a mechanized application, replace the nozzle and the electrode together.
- The cutting speed is not correct. See the cut charts under *Using the cut charts* on page 73.
- The current (amperage) is set too low. See the cut charts under *Using the cut charts* on page 73.



The cut angle is not square.

- The torch is not square to the workpiece.
- The gas setting is incorrect.
- The consumables are worn and need to be replaced. For optimized performance in a mechanized application, replace the nozzle and the electrode together.
- The direction of the torch travel is incorrect. The high-quality cut is always on the right with respect to the forward motion of the torch.
- The torch-to-work distance/cut height is too large or too small.
- The cutting speed is not correct. See the cut charts under *Using the cut charts* on page 73.

The consumable life is shortened.

- The gas setting is incorrect.
- The arc current, arc voltage, travel speed, and other variables are not set as recommended in the cut charts.
- Firing the arc in the air (beginning or ending the cut off of the plate surface). Starting at the edge is acceptable as long as the arc makes contact with the workpiece when started.
- Starting a pierce with an incorrect torch height. Refer to the cut charts for the specific initial pierce height.
- The pierce time is incorrect.
- The air quality is poor (oil or water in the air).
- There might be a faulty pilot arc IGBT, which can shorten nozzle life (refer to *Maintenance and Repair* on page 105, or contact your closest Hypertherm technical service in the front of this manual).
- The swirl ring or retaining cap is worn and needs to be replaced.

Perform routine maintenance

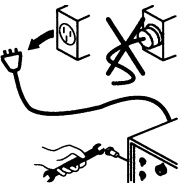
		<p>WARNING! ELECTRIC SHOCK CAN KILL</p>
		<p>Disconnect electrical power before performing any maintenance that involves removing the cover from the power supply or the consumables from the torch.</p> <p>All work requiring removal of the power supply cover must be performed by a qualified technician.</p> <p>Read the separate <i>Safety and Compliance Manual</i> included with your system for more safety precautions.</p>

Routine maintenance tasks

Every use:

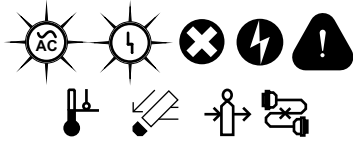

Check indicator lights and fault icons.
Correct any fault conditions.

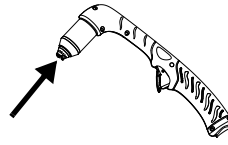

Inspect the consumables for proper installation and wear.

Every 3 months:

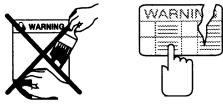

Replace any damaged labels.

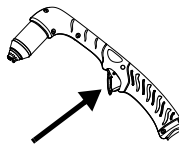

Inspect the trigger for damage.
Inspect the torch body for cracks and exposed wires. Replace any damaged parts.

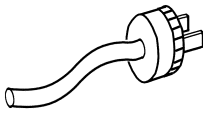

Inspect the power cord and plug. Replace if damaged.

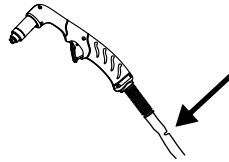

Inspect the torch lead. Replace if damaged.

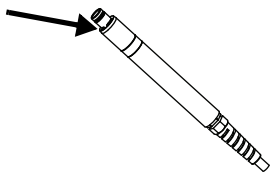

Inspect the screws on the machine torch that connect the torch body to the mounting sleeve. Tighten the screws, if needed.

Every 6 months:

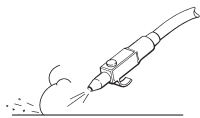



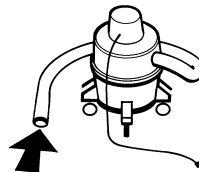

or

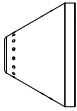

Clean the inside of the power supply with moisture-free compressed air or a vacuum.

Inspect the Powermax125 consumables

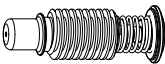
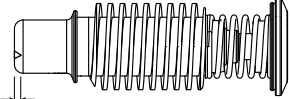
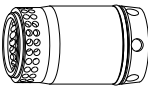
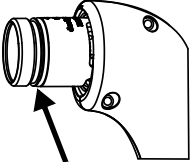
Part	Inspect	Action
 Shield	The center hole for roundness.	Replace the shield if the hole is no longer round.
	The gap between the shield and the nozzle for accumulated debris.	Remove the shield and clean away any material.
 Nozzle	The center hole for roundness.   Good Worn	Replace nozzle if the center hole is not round.
 Electrode	 Max. 1 mm (0.4 inch)	Replace electrode if the surface is worn or the pit depth is greater than 1 mm (0.4 inch) deep.
 Swirl ring	The surface inside the swirl ring for damage or wear and the gas holes for blockages.	Replace swirl ring if the surface is damaged or worn or any of the gas holes are blocked.
	The O-ring for damage or wear.	If the O-ring is worn or damaged, replace the swirl ring. (See <i>Parts</i> on page 119.)
	The length of the swirl ring.	If the length of the 220997 or 420159 swirl ring is less than 32 mm (1.27 inches), replace it.
 Torch o-ring	The surface for damage, wear, or a lack of lubrication.	If the O-ring is dry, lubricate it and the threads with a thin layer of silicone lubricant. If the o-ring is worn or damaged, replace it. (See <i>Parts</i> on page 119.)

Basic troubleshooting

The following table provides an overview of the most common problems that can arise when using the system and explains how to solve them.



Fault icons and corresponding fault codes appear in the LCD display. See *Fault codes and solutions* on page 109.

If a fault occurs while using a generator, turn OFF the power supply, wait 60 to 70 seconds, and turn ON the power supply.

If you are unable to fix the problem by following this basic troubleshooting guide, or if you need further assistance:

1. Call your Hypertherm distributor or authorized Hypertherm repair facility.
2. Call the nearest Hypertherm office listed in the front of this manual.

Troubleshooting guide

Problem	Solutions
The ON/OFF power switch is set to ON (I), but the power ON LED is not illuminated.	<ul style="list-style-type: none">▪ Verify that the power cord is plugged into the receptacle.▪ Verify that the power is ON at the main power panel or at the line-disconnect switch box.▪ Verify that the line voltage is not too low (more than 15% below the rated voltage).▪ Verify that the fuses in the disconnect are not blown.
The arc does not transfer to the workpiece.	<ul style="list-style-type: none">▪ Clean the area where the ground clamp contacts the workpiece to ensure a good metal-to-metal connection.▪ Inspect the ground clamp for damage, and repair as necessary.▪ The pierce-height distance may be too large. Move the torch closer to the workpiece and fire the torch again.
The arc blows out, but re-ignites when the torch trigger is pressed again.	<ul style="list-style-type: none">▪ Inspect the consumable parts and replace them if they are worn or damaged. See <i>Inspect the Powermax125 consumables</i> on page 107.▪ Replace the gas filter element if it is contaminated. See <i>Replace the air filter element and air filter bowl</i> on page 114.▪ Make sure the gas pressure is at the proper level.
The arc sputters and hisses.	<ul style="list-style-type: none">▪ The gas filter element is contaminated. Replace the element. See <i>Replace the air filter element and air filter bowl</i> on page 114.▪ Inspect the gas line for moisture. If necessary, install or repair the gas filtration to the power supply. See <i>Power Supply Setup</i> on page 25.

Problem	Solutions
The cut quality is poor.	<ul style="list-style-type: none"> ▪ Verify that the torch is being used correctly. See <i>Basic System Operations</i> on page 35, <i>Hand Cutting</i> on page 53, or <i>Mechanized Cutting</i> on page 95. ▪ Inspect the consumables for wear and replace as necessary. See <i>Inspect the Powermax125 consumables</i> on page 107. ▪ Check the air pressure and air quality. ▪ Verify that the cutting mode switch is in the proper position for the cutting operation. ▪ Verify that the correct consumables are installed.



Fault codes and solutions

A label with descriptions for these common fault codes can be found inside the front cover of the *Operator Manual*. Peel off the label and place it on the top of the power supply for reference.

















If a fault occurs while using a generator, turning the power switch quickly to OFF and then to ON again (sometimes called a “quick reset” or “quick restart”) may not clear the fault. Instead, turn OFF the power supply and wait 60 to 70 seconds before turning ON again.

Fault codes

Fault code	Description	Power LED	Fault LED	Fault icon	Solutions
0-12	Low input gas pressure or unstable gas pressure: Warning (the system continues to operate)	On	Off		<ul style="list-style-type: none"> ▪ Adjust the gas inlet pressure as needed.
0-13	AC input unstable: Warning (the system continues to operate)	Blinks (3 Hz)	Off		<ul style="list-style-type: none"> ▪ Correct the power source.

8 – Maintenance and Repair

Fault code	Description	Power LED	Fault LED	Fault icon	Solutions
0-19	Power board hardware protection. One or more power board hardware faults (or noise) detected.	On	On		<ul style="list-style-type: none"> The inverter shuts down and does not fire again for several seconds. If the fault is caused by electrical noise, the fault clears in a few seconds and the machine operates normally. A true 0-19 fault may display for up to 60 seconds before fault code 0-99 displays on the operator screen. A qualified service technician must service the system. Contact your distributor or authorized repair facility. Can indicate a fault that occurs 10 times without removing power. Fault code 0-99 displays. A qualified service technician must service the system. Contact your distributor or authorized repair facility.
0-20	Low gas pressure	On	On		<ul style="list-style-type: none"> Check the input gas supply. Adjust the gas pressure to the acceptable range using Manual mode. See <i>Basic System Operations</i> on page 35. Perform a quick restart.
0-21	Excessive arc voltage change: check consumables, gas flow	On	On		<ul style="list-style-type: none"> Restore the gas inlet pressure and restart the power supply. Check the torch lead for leaks or kinking. Change consumables.
0-22	No gas input	On	On		<ul style="list-style-type: none"> Connect the gas source and restart the power supply.
0-30	Torch consumables stuck This indicates either a “torch stuck open” or a “torch stuck closed” situation.	On	On		<ul style="list-style-type: none"> If the consumables became loose or were removed while the power supply is ON, turn OFF the power supply, correct the problem and then turn ON the power supply to clear this fault. Change consumables. If the consumables appear to be installed correctly, the torch may be damaged. Contact your Hypertherm distributor or authorized repair facility.
0-32	End of consumable life	On	On		<ul style="list-style-type: none"> Replace the electrode and nozzle. Check the remaining consumables for wear and replace as needed.

Fault code	Description	Power LED	Fault LED	Fault icon	Solutions
0-40	Over/under temperature	On	On		<ul style="list-style-type: none"> Leave the power supply on to allow the fan to cool the power supply. If the internal temperature of the power supply approaches -30° C (-22° F), move the power supply to a warmer location.
0-50	Retaining cap off	On	On		<ul style="list-style-type: none"> Turn OFF the power supply. Verify that the consumables are installed and restart the power supply. If the consumables appear to be installed correctly, the torch may be damaged. Contact your Hypertherm distributor or authorized repair facility.
0-51	Start/trigger signal on at power up This situation indicates that the power supply is receiving a start signal. It is sometimes referred to as a “stuck start.”	On	On		<ul style="list-style-type: none"> If the power supply is turned on while the torch trigger is pressed, the system is disabled. Release the trigger and recycle the power switch.
0-52	Torch not connected	On	On		<ul style="list-style-type: none"> Plug a torch lead into the FastConnect receptacle on the front of the power supply and recycle the power switch.
0-60	AC input voltage error	On	On		<ul style="list-style-type: none"> Phase loss: Check all input phases and fuses. Over voltage: Check the line, decrease the voltage. Under voltage: Check the line, increase the voltage.
0-61	AC input unstable: Shutdown	On	On		<ul style="list-style-type: none"> The incoming line current is unstable. Power down and correct the line problem before continuing.
0-98	Internal communication failure	On	On		<ul style="list-style-type: none"> Power down, wait 20 seconds, power up. A qualified service technician must open the power supply case and check the ribbon cable between the control board and the DSP board.
0-99	System hardware fault – service required Indicates a major fault with the system.	On	On		<ul style="list-style-type: none"> A qualified service technician must service the system. Contact your distributor or authorized repair facility.

Display the service screen

You can view system information that aids troubleshooting by accessing the service screen. This screen displays recent fault codes, arc hours, the software version your system is running, and several additional details. You can also run a gas test from this screen.

For example, if a fault code displays on the status screen (in the format *N-nn*) while you are operating the system, you can check the service screen for an additional four-digit fault code (in the format *N-nn-n*). If qualified service technicians must service the system, these four-digit fault codes help them diagnose the problem.

To display the service screen, simultaneously press the automatic/manual and current/gas mode selectors for approximately two seconds.

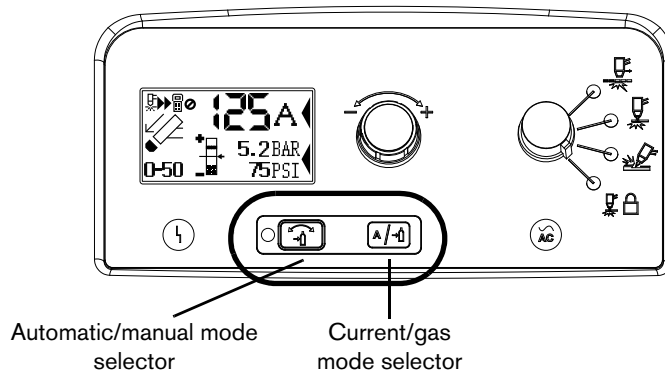

To navigate the service screen, move the field selector (*) between fields by pressing the current/gas mode selector. The asterisk (*) indicates the selected field.

To exit the service screen, simultaneously press the automatic/manual and current/gas mode selectors. The operator screen displays.



Designator	Description
I	Current set/read
C	LCD contrast
B	LCD brightness (percent)
P	Pressure set/read
G	Gas test enable (1)/disable (0)

Designator	Description
VL	Incoming AC line voltage
TI	Inverter module temperature (°C)
VB	DC bus voltage
AH	Arc hours
F	Live four-digit fault code for diagnosing system errors
T	Torch identifier (amperage/hand (H) or machine (M)/lead length in feet)
S	DSP/control board software versions
(callouts 1 – 6)	Fault log of recent fault codes recorded by the system (0-00-0) and the last three digits of the arc hour count when the fault occurred (000).

Run a gas test

	CAUTION!
<p>Point the torch away from you before performing a gas test. Always keep hands, clothes, and objects clear of the torch tip, and never point the torch toward yourself or others.</p>	

1. Display the service screen by simultaneously pressing the automatic/manual and current/gas mode selectors for approximately two seconds.
2. Select the gas test field by pressing the current/gas mode selector until the asterisk (*) is next to the “G.”
3. Use the adjustment knob to set the gas test field from 0 to 1.

If gas does not flow, call your Hypertherm distributor or authorized Hypertherm repair facility, or call the nearest Hypertherm office listed in the front of this manual.

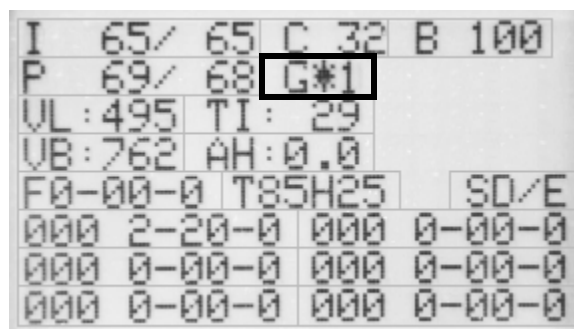

4. Use the adjustment knob to set the gas test field back to 0.
5. Simultaneously press the automatic/manual and current/gas mode selectors to exit the service screen.

Replace the air filter element and air filter bowl

Remove the air filter bowl

1. Turn OFF the power, disconnect the power cord, and make sure the gas supply is disconnected. Position the rear of the power supply so the removable gas filter bowl is easily accessible.

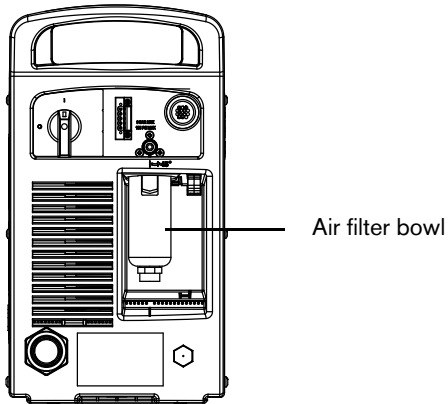

2. If the consumables case is positioned next to the air filter bowl, remove it first.
3. Grasp the filter bowl with your right hand. Push down the thumb latch and turn the filter bowl approximately 45 degrees to the right.
4. Pull the filter bowl straight down to remove.

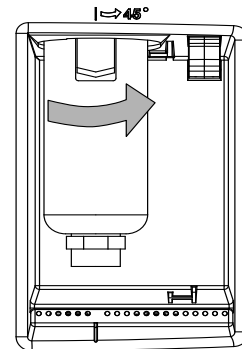

Identify air filter bowl model

Due to a manufacturing change, your Powermax125 may have one of the two air filter bowl models shown below. The bowl styles and O-rings are not interchangeable. Both filter bowls use the same air filter element, but the steps to replace the element will vary for each bowl.

Old metal guarded filter bowl



The air filter assembly that has a metal guarded filter bowl is no longer available to order. The individual air filter element and metal guarded bowl are still available to order.

To replace the air filter element and bowl on this assembly, skip to page 117.

New plastic filter bowl



To replace the air filter element and plastic or nylon filter bowl, continue to the next section.

 The filter bowl may also appear greenish-blue if you install optional nylon bowl kit 428415. (See page 121).

Install the air filter element (for plastic or nylon bowl)

5. Twist and pull up on the black element retainer at the top of the filter bowl.

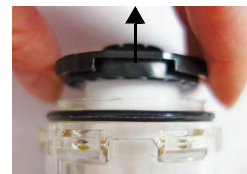

6. Gently twist the black element retainers **1** until they come apart and you can remove the dirty air filter element **2** from them.

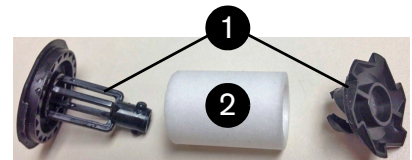

8 – Maintenance and Repair

7. Gently twist the element retainers until they lock together and fit snugly against the new element.



If the black element retainers are damaged, order a new air filter assembly in kit 428351, or 228685 if still available from factory.

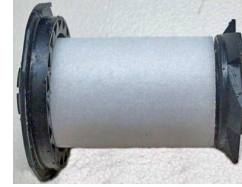

8. If you are not replacing the air filter bowl:

- ❑ Install the thicker O-ring in kit 228695, onto the existing filter bowl.



Use thicker O-ring.

O-ring



- ❑ Clean the bowl by wiping away any oil, dirt, or other contaminants.

9. Place the air filter element in the filter bowl. Twist the filter element's top plastic part until it fastens securely to the top of the filter bowl.



To install the air filter bowl, continue to step 10 on page 118.



Install the air filter element (for metal guarded bowl)

5. You can see the white filter element and black retaining nut on the filter assembly. Unscrew (counterclockwise) the plastic retaining nut that secures the filter element.
6. Replace the dirty element with the new white element.
7. Reinstall (clockwise) the original plastic retaining nut to finger-tight only.
8. Wipe away any oil, dirt, or other contaminants inside of the filter bowl to make sure it is clean.
9. Examine the O-ring at the top of the filter bowl.



- If the O-ring is damaged, replace it with the thinner of the two O-rings in kit 228695.

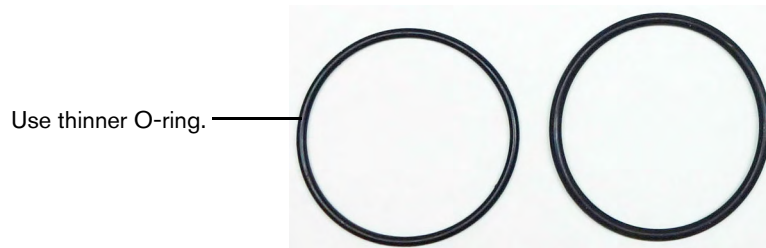

- If the O-ring is not damaged, make sure it is lightly lubricated with silicone lubricant (027055 not included).

Install the air filter bowl (metal guarded, plastic, or nylon)

10. Vertically align the filter bowl and firmly push the filter bowl up to the top of the receptacle to seat the bowl.
11. Once the bowl is seated properly, rotate the bowl 45 degrees to the left until you hear the thumb latch click into place.

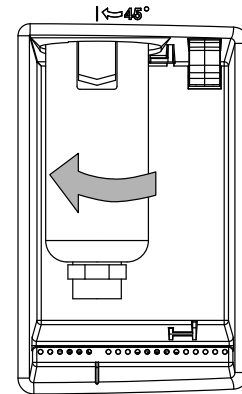

12. Reconnect the gas supply hose to the power supply and check for leaks.
13. Reconnect the electrical power and turn ON the power switch.

Section 9

Parts

Use the Hypertherm kit numbers in this section to order replacement parts, consumables, and accessories for your power supply, hand torch, and machine torch.

For instructions on installing the gas filter element in the power supply, see *Replace the air filter element and air filter bowl* on page 114.

For instructions on installing the consumables in the hand torches, see *Install the hand torch consumables* on page 50.

For instructions on installing the consumables in the machine torches, see *Install the machine torch consumables* on page 71.

Power supply parts

Exterior, front

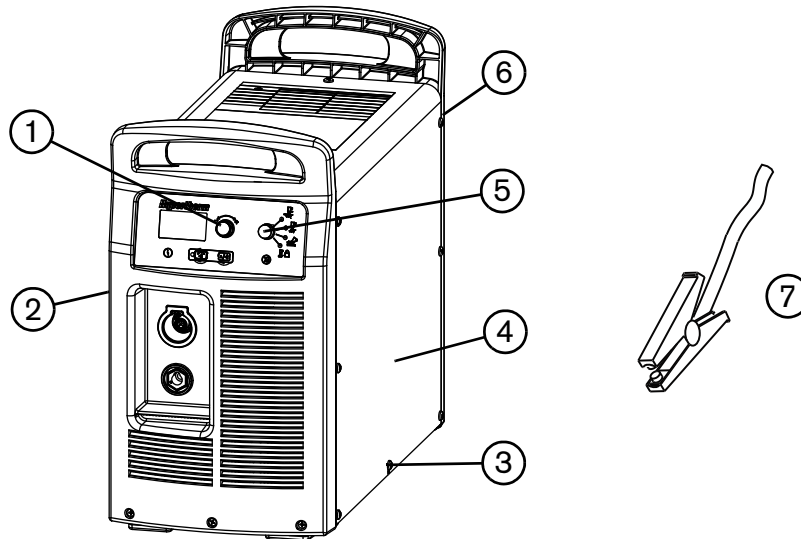

Part Number	Description
1 428143	Kit: Adjustment knob
2 228866	Kit: Powermax105/125 front panel
3 428141	Kit: Powermax105/125 cover screws
4 428115	Kit: Powermax125 CSA power supply cover with labels
4 428116	Kit: Powermax125 CE power supply cover with labels
4 428247	Kit: Powermax125 CCC power supply cover with labels
5 428142	Kit: Operating mode knob
6 428110	Kit: Powermax125 480V CSA rear panel
6 428112	Kit: Powermax125 600V CSA rear panel
6 428111	Kit: Powermax125 400V CE rear panel
6 428113	Kit: Powermax125 380V CCC rear panel
7	Work lead (See <i>Accessory parts</i> on page 130.)

Exterior, rear

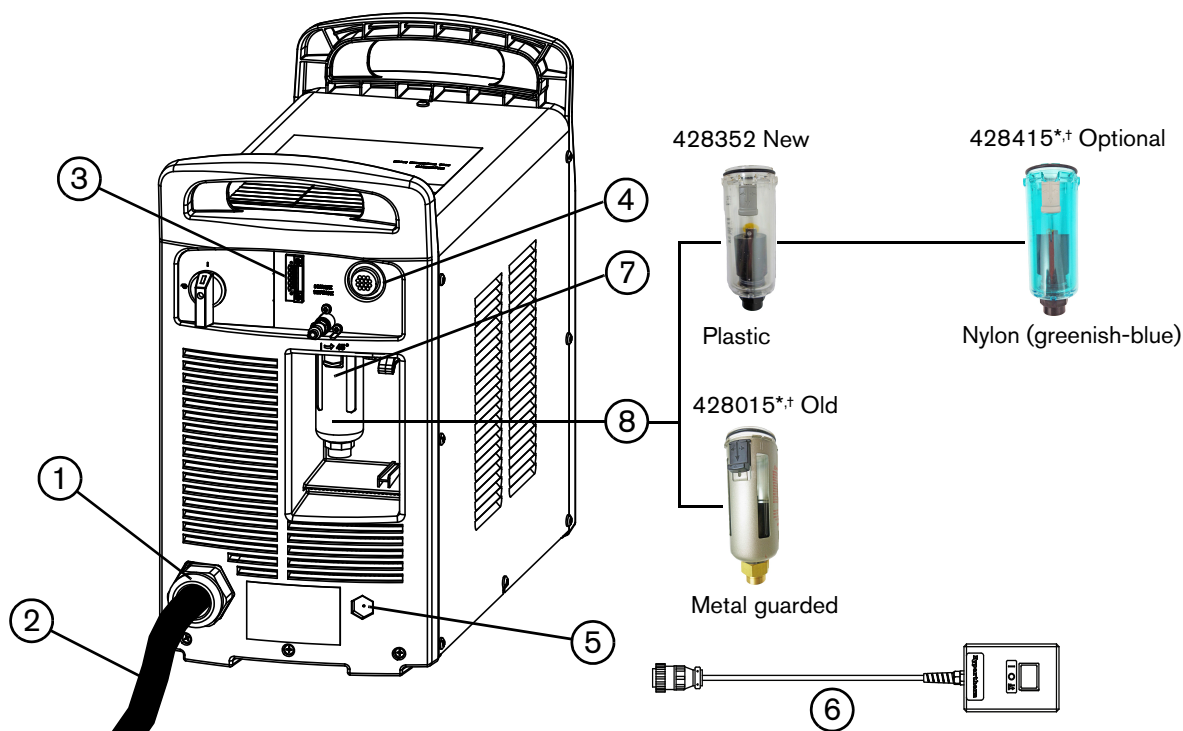

Part Number	Description
1 228914	Kit: Powermax105 power cord strain relief 400 V CE/380 V CCC; Powermax125 power cord strain relief 480 V and 600 V CSA/380 V CCC
1 228913	Kit: Powermax105 power cord strain relief 230 – 400 V CE; Powermax125 power cord strain relief 400 V CE
2 428121	Kit: Powermax125 power cord with strain relief 480 V and 600 V CSA
2 228886	Kit: Powermax105 power cord with strain relief 230 – 400 V CE; Powermax125 power cord with strain relief 400 V CE
3 228539	Kit: Serial interface port, internal cables, and RS-485 board
223236	RS-485 cable, unterminated, 7.6 m (25 feet)
223237	RS-485 cable, unterminated, 15 m (50 feet)
223239	RS-485 cable, 9-pin D-sub connector for Hypertherm controls, 7.6 m (25 feet)
223240	RS-485 cable, 9-pin D-sub connector for Hypertherm controls, 15 m (50 feet)
4 228884	Kit: Powermax105/125 machine interface cable, internal cable with voltage divider board (CPC port)
127204	Cover for Powermax45/65/85/105/125 machine interface (CPC) receptacle
023206	External machine interface cable (start, stop, arc transfer signals), 7.6 m (25 feet), spade connectors

Part Number	Description
023279	External machine interface cable (start, stop, arc transfer signals), 15 m (50 feet), spade connectors
228350	Kit: External Machine interface cable (start, stop, arc transfer signals) for divided arc voltage, 7.6 m (25 feet), spade connectors
228351	Kit: External machine interface cable (start, stop, arc transfer signals) for divided arc voltage, 15 m (50 feet), spade connectors
223354	External machine interface cable (start, stop, arc transfer signals) for divided arc voltage, 3.0 m (10 feet), D-sub connector with screws
223355	External machine interface cable (start, stop, arc transfer signals) for divided arc voltage, 6.1 m (20 feet), D-sub connector with screws
223048	External machine interface cable (start, stop, arc transfer signals) for divided arc voltage, 7.6 m (25 feet), D-sub connector with screws
223356	External machine interface cable (start, stop, arc transfer signals) for divided arc voltage, 10.7 m (35 feet), D-sub connector with screws
123896	External machine interface cable (start, stop, arc transfer signals) for divided arc voltage, 15 m (50 feet), D-sub connector with screws
5 228711	Kit: Powermax65/85/105/125 machine interface for raw arc voltage (strain relief)
6 128650	Remote start pendant for machine torch, 7.6 m (25 feet)
6 128651	Remote start pendant for machine torch, 15 m (50 feet)
6 128652	Remote start pendant for machine torch, 23 m (75 feet)
6 428755	Remote start pendant for machine torch, 45.7 m (150 feet)
7 228695	Kit: Powermax65/85/105/125 air filter element (inside filter bowl) and O-ring (compatible with all bowl types)
8 428352* [†]	Kit: Powermax65/85/105/125 plastic air filter bowl (includes O-ring)
8 428415* [†]	Kit: Powermax65/85/105/125 optional nylon air filter bowl (includes O-ring) (greenish-blue)
8 428015 [‡]	Kit: Powermax65/85/105/125 metal guarded air filter bowl (includes O-ring)

* Filter bowl kit 428352 and 428415 only fit on air filter assembly kit 428351 (see page 123).

[†] The plastic air filter bowl (kit 428352) that comes with the Powermax125 is compatible with most air systems, but the airline should be maintained clean. Organic solvents, chemicals, cutting oil, synthetic oil, alkali, and thread lock solutions may cause harmful effects to the plastic air filter bowl. An optional nylon bowl (kit 428415) is available for sites that have difficulty preventing harsh chemicals from entering the air system.

[‡] The filter bowl kits are not interchangeable. Filter bowl kit 428015 only fits on old air filter assembly kit 228685 (see page 123). Order kit 428015 if you currently have a metal guarded filter bowl (see page 121).

Interior, fan side

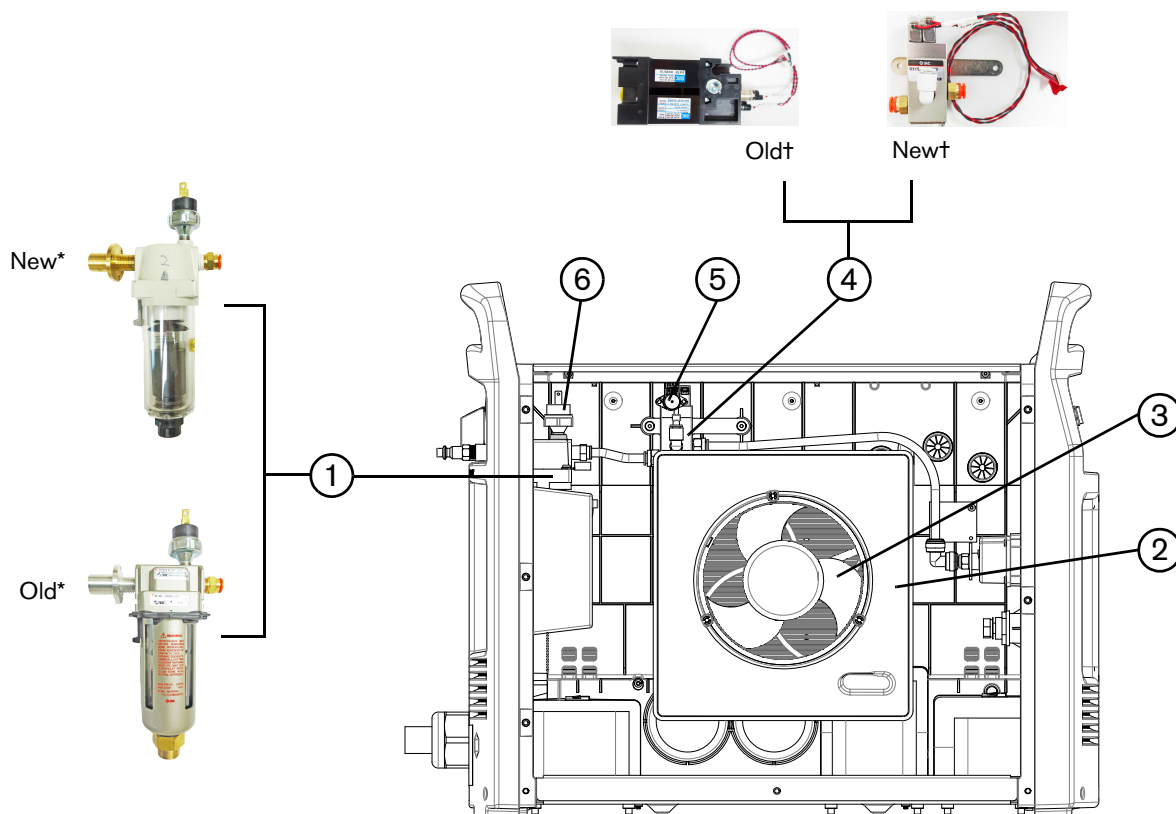

Part Number	Description
1 428351*	Kit: Powermax65/85/105/125 air filter assembly (includes filter bowl, filter element, and O-ring)
1 228685*	Kit: Powermax65/85/105/125 old air filter assembly with guarded metal bowl
2 228910	Kit: Powermax105/125 fan shroud
3 228881	Kit: Powermax105/125 fan assembly
4 228687†	Kit: Powermax105/125 regulator/solenoid valve (new) (includes tubing and screws)
5 228689	Kit: Powermax65/85/105/125 pressure transducer
6 228688	Kit: Powermax65/85/105/125 pressure switch

* Because of a manufacturing change, the new air filter assembly in kit 428351 replaces the old air filter assembly in kit 228685. Although kit 228685 is no longer available to order, you can still order its individual filter bowl and filter element (see page 122).

† Because of a manufacturing change, new solenoid valve kit 228687 replaces old solenoid valve kit 228882.

Duramax Hyamp 85° hand torch replacement parts

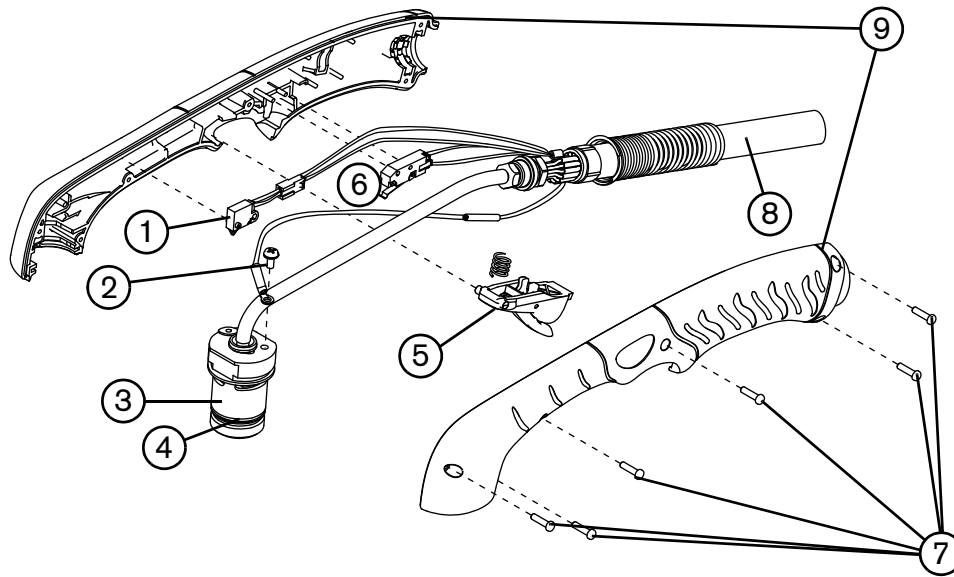

The entire hand torch and lead assembly can be replaced, or individual component parts can be replaced. Part numbers starting with 059 indicate complete torch and lead assemblies.

Part Number	Description
059492*	Duramax Hyamp 85° hand torch assembly with 7.6 m (25 foot) lead
059493*	Duramax Hyamp 85° hand torch assembly with 15 m (50 foot) lead
059494*	Duramax Hyamp 85° hand torch assembly with 23 m (75 foot) lead
1 228719	Kit: Duramax and Duramax Hyamp hand torch cap-sensor switch replacement
2 075696	Pilot terminal screw
3 428158	Kit: Duramax Hyamp 85° hand torch main body replacement
4 428253	Kit: Duramax Hyamp O-ring replacement (5)
5 428156	Kit: Duramax Hyamp hand torch trigger with spring replacement
6 428162	Kit: Duramax Hyamp start switch replacement
7 428148	Kit: Duramax Hyamp hand torch handle screws
8 428159	Kit: Duramax Hyamp hand torch lead replacement, 7.6 m (25 foot)
8 428160	Kit: Duramax Hyamp hand torch lead replacement, 15 m (50 foot)
8 428161	Kit: Duramax Hyamp hand torch lead replacement, 23 m (75 foot)
8 428762	Kit: Duramax Hyamp hand torch lead replacement, 45.7 m (150 foot)
9 428155	Kit: Duramax Hyamp 85° torch handle replacement
428260	Kit: Duramax and Duramax Hyamp torch quick disconnect repair (lead side)

* The torch assembly does not include consumables. See page 126 for a list of consumable part numbers.

Duramax Hyamp 15° hand torch replacement parts

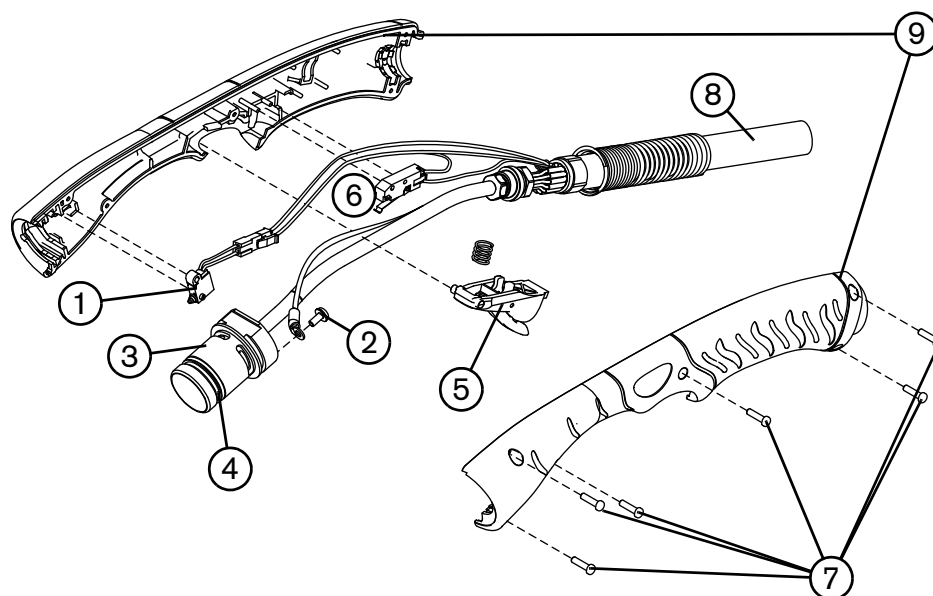

The entire hand torch and lead assembly can be replaced, or individual component parts can be replaced. Part numbers starting with 059 indicate complete torch and lead assemblies.

Part Number	Description
059495*	Duramax Hyamp 15° hand torch assembly with 7.6 m (25 foot) lead
059496*	Duramax Hyamp 15° hand torch assembly with 15 m (50 foot) lead
059497*	Duramax Hyamp 15° hand torch assembly with 23 m (75 foot) lead
1 228719	Kit: Duramax and Duramax Hyamp hand torch cap-sensor switch replacement
2 075696	Pilot terminal screw
3 428157	Kit: Duramax Hyamp 15° hand torch main body replacement
4 428253	Kit: Duramax Hyamp O-ring replacement (5)
5 428156	Kit: Duramax Hyamp hand torch trigger with spring replacement
6 428162	Kit: Duramax Hyamp start switch replacement
7 428148	Kit: Duramax Hyamp hand torch handle screws
8 428159	Kit: Duramax Hyamp hand torch lead replacement, 7.6 m (25 feet)
8 428160	Kit: Duramax Hyamp hand torch lead replacement, 15 m (50 feet)
8 428161	Kit: Duramax Hyamp hand torch lead replacement, 23 m (75 feet)
8 428762	Kit: Duramax Hyamp hand torch lead replacement, 45.7 m (150 feet)
9 428154	Kit: Duramax Hyamp 15° torch handle replacement
428260	Kit: Duramax and Duramax Hyamp torch quick disconnect repair (lead side)

* The torch assembly does not include consumables. See page 126 for a list of consumable part numbers.

Hand torch consumables**Drag cutting**

Part Number	Description
420172	Duramax Hyamp shield 45/65 A
420000	Duramax Hyamp shield 105/125 A
220977	Duramax Hyamp retaining cap
420158	Duramax Hyamp nozzle 45 A
420169	Duramax Hyamp nozzle 65 A
220975	Duramax Hyamp nozzle 105/125 A
220971	Duramax Hyamp electrode
220997	Duramax Hyamp swirl ring

Gouging

Part Number	Description
420112	Duramax Hyamp gouging shield
220977	Duramax Hyamp retaining cap
420001	Duramax Hyamp gouging nozzle
220971	Duramax Hyamp electrode
220997	Duramax Hyamp swirl ring

FineCut

Part Number	Description
420152	Duramax Hyamp FineCut shield
220977	Duramax Hyamp retaining cap
420151	Duramax Hyamp FineCut nozzle
220971	Duramax Hyamp electrode
420159	Duramax Hyamp FineCut swirl ring

Duramax Hyamp 180° full-length machine torch replacement parts

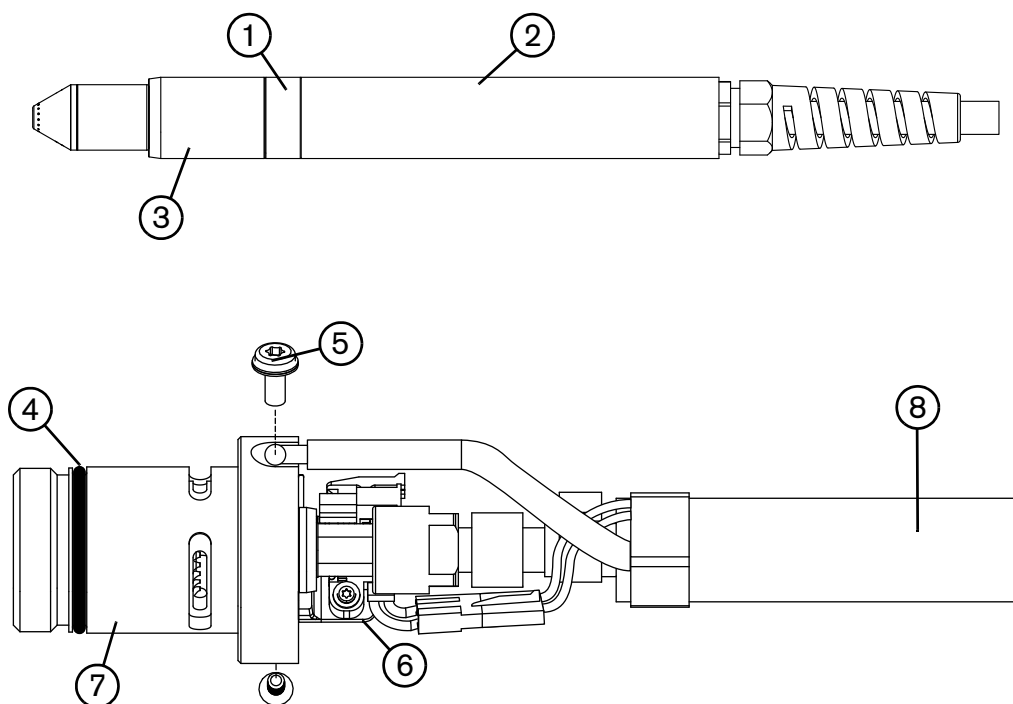

The entire machine torch and lead assembly can be replaced, or individual component parts can be replaced. Part numbers starting with 059 indicate complete torch and lead assemblies.

Part Number	Description
059519*	Duramax Hyamp 180° full-length machine torch assembly with 4.6 m (15 feet) lead
059520*	Duramax Hyamp 180° full-length machine torch assembly with 7.6 m (25 feet) lead
059521*	Duramax Hyamp 180° full-length machine torch assembly with 10.7 m (35 feet) lead
059522*	Duramax Hyamp 180° full-length machine torch assembly with 15 m (50 feet) lead
059523*	Duramax Hyamp 180° full-length machine torch assembly with 23 m (75 feet) lead
1 428248	Kit: Duramax Hyamp 180° machine torch coupler
2 428144	Kit: Duramax Hyamp 180° full-length machine torch positioning sleeve
3 428145	Kit: Duramax Hyamp 180° machine torch mounting sleeve
4 428253	Kit: Duramax Hyamp O-ring replacement (5)
5 075696	Pilot terminal screw
6 228720	Kit: Duramax/Hyamp/MRT 180° machine torch cap-sensor switch replacement
7 428147	Kit: Duramax Hyamp 180° machine torch main body replacement
8 428149	Kit: Duramax Hyamp 180° machine torch lead replacement, 4.6 m (15 feet)
8 428150	Kit: Duramax Hyamp 180° machine torch lead replacement, 7.6 m (25 feet)

Part Number	Description
8 428151	Kit: Duramax Hyamp 180° machine torch lead replacement, 10.7 m (35 feet)
8 428152	Kit: Duramax Hyamp 180° machine torch lead replacement, 15 m (50 feet) Kit:
8 428153	Duramax Hyamp 180° machine torch lead replacement, 23 m (75 feet)
8 428761	Kit: Duramax Hyamp 180° machine torch lead replacement, 45.7 m (150 feet)
428260	Kit: Duramax and Duramax Hyamp torch quick disconnect repair (lead side)

* The torch assembly does not include consumables. See page 129 for a list of consumable part numbers.

Duramax Hyamp 180° mini machine torch replacement parts

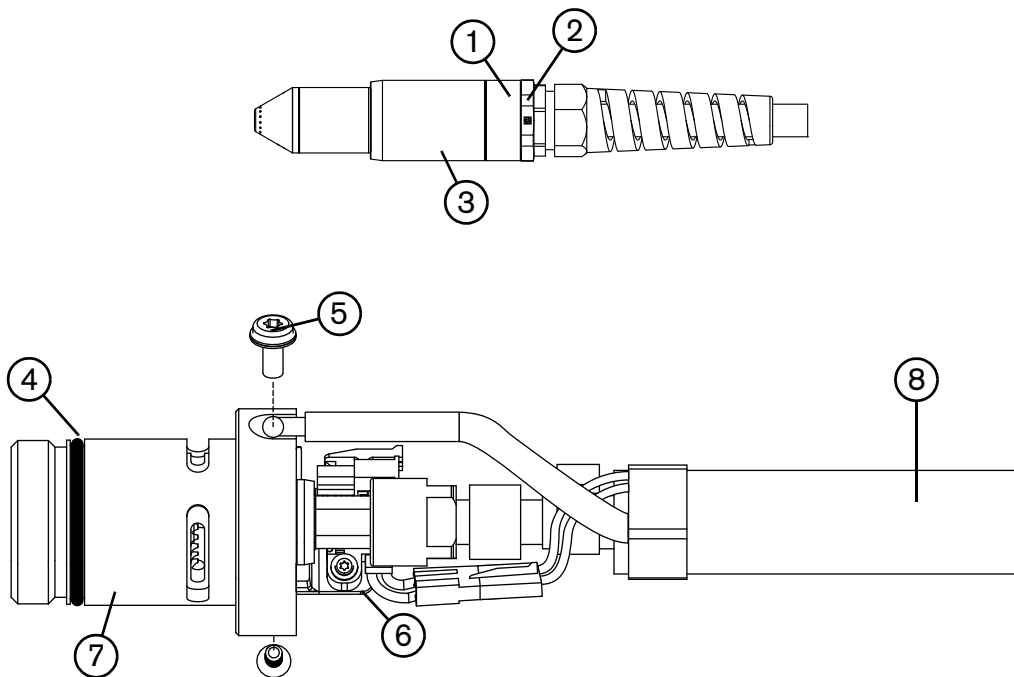

The entire machine torch and lead assembly can be replaced, or individual component parts can be replaced. Part numbers starting with 059 indicate complete torch and lead assemblies.

Part Number	Description
059514*	Duramax Hyamp 180° mini machine torch assembly with 4.6 m (15 foot) lead
059515*	Duramax Hyamp 180° mini machine torch assembly with 7.6 m (25 foot) lead
059516*	Duramax Hyamp 180° mini machine torch assembly with 10.7 m (35 foot) lead
059517*	Duramax Hyamp 180° mini machine torch assembly with 15 m (50 foot) lead
1 428248	Kit: Duramax Hyamp 180° machine torch coupler
2 428146	Kit: Duramax Hyamp 180° mini machine torch adapter ring
3 428145	Kit: Duramax Hyamp 180° machine torch mounting sleeve

Part Number	Description
4 428253	Kit: Duramax Hyamp O-ring replacement (5)
5 075696	Pilot terminal screw
6 228720	Kit: Duramax/Hyamp/MRT 180° machine torch cap-sensor switch replacement
7 428147	Kit: Duramax Hyamp 180° machine torch main body replacement
8 428149	Kit: Duramax Hyamp 180° machine torch lead replacement, 4.6 m (15 feet)
8 428150	Kit: Duramax Hyamp 180° machine torch lead replacement, 7.6 m (25 feet)
8 428151	Kit: Duramax Hyamp 180° machine torch lead replacement, 10.7 m (35 feet)
8 428152	Kit: Duramax Hyamp 180° machine torch lead replacement, 15 m (50 feet)
8 428761	Kit: Duramax Hyamp 180° machine torch lead replacement, 45.7 m (150 feet)
428260	Kit: Duramax and Duramax Hyamp torch quick disconnect repair (lead side)

* The torch assembly does not include consumables. See page 129 for a list of consumable part numbers.

Machine torch consumables

Shielded

Part Number	Description
420168	Duramax Hyamp shield 45/65 A
220976	Duramax Hyamp shield 105/125 A
220977	Duramax Hyamp retaining cap
420156	Duramax Hyamp Ohmic retaining cap
420158	Duramax Hyamp nozzle 45 A
420169	Duramax Hyamp nozzle 65 A
220975	Duramax Hyamp nozzle 105/125 A
220971	Duramax Hyamp electrode
220997	Duramax Hyamp swirl ring

Gouging

Part Number	Description
420112	Duramax Hyamp gouging shield
220977	Duramax Hyamp retaining cap
420001	Duramax Hyamp gouging nozzle
220971	Duramax Hyamp electrode
220997	Duramax Hyamp swirl ring

FineCut

Part Number	Description
420152	Duramax Hyamp FineCut shield
220977	Duramax Hyamp retaining cap
420156	Duramax Hyamp Ohmic retaining cap
420151	Duramax Hyamp FineCut nozzle
220971	Duramax Hyamp electrode
220997	Duramax Hyamp swirl ring

Accessory parts

Part Number	Description
024877	Black leather torch sheathing with Hypertherm logo, 7.6 m (25 foot)
127360	Powermax105/125 dust cover
228890	Kit: Eliminer gas filter with protective metal cover for the Powermax105/125
101215	Kit: Eliminer gas filter protective metal cover for the Powermax105/125 (cover
223292	only) Kit: 125 A work lead with hand clamp, 7.6 m (25 feet)
223293	Kit: 125 A work lead with hand clamp, 15 m (50 feet)
223294	Kit: 125 A work lead with hand clamp, 23 m (75 feet)
223737	Kit: 125 A work lead with hand clamp, 45.7 m (150 feet)
223298	Kit: 125 A work lead with C-style clamp, 7.6 m (25 feet)
223299	Kit: 125 A work lead with C-style clamp, 15 m (50 feet)
223300	Kit: 125 A work lead with C-style clamp, 23 m (75 feet)
223295	Kit: 125 A work lead with ring terminal, 7.6 m (25 feet)
223296	Kit: 125 A work lead with ring terminal, 15 m (50 feet)
223297	Kit: 125 A work lead with ring terminal, 23 m (75 feet)
223744	Kit: 125 A work lead with ring terminal, 45.7 m (150 feet)
008539	Ground hand clamp: 500 A
229467	Kit: Powermax105/125 wheel kit assembly
229570	Kit: Powermax105/125 gantry mount frame

Powermax125 labels

Part Number	Description
428117	Kit: Powermax125 labels, CSA
428118	Kit: Powermax125 labels, CE
428257	Kit: Powermax125 labels, CCC

The label kits include the consumables label, appropriate safety labels, display panel label, power switch label, and side decals.

The following illustrations show the consumables label and safety labels.

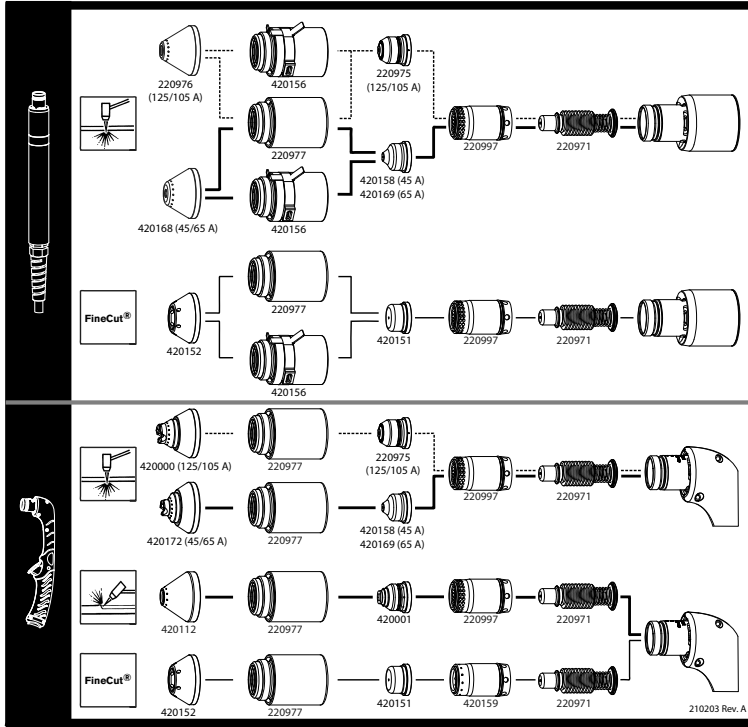

Consumables label



CE/CCC safety label

Read and follow these instructions, employer safety practices, and material safety data sheets. Refer to ANS Z49.1, "Safety in Welding, Cutting and Allied Processes" from American Welding Society (http://www.aws.org) and OSHA Safety and Health Standards, 29 CFR 1910 (http://www.osha.gov).		WARNING		AVERTISSEMENT	
		1. Cutting sparks can cause explosion or fire. 1.1 Do not cut near flammables. 1.2 Have a fire extinguisher nearby and ready to use. 1.3 Do not use a drum or other closed container as a cutting table.		1. Les étincelles de coupe peuvent provoquer une explosion ou un incendie. 1.1 Ne pas couper près des matières inflammables. 1.2 Un extincteur doit être à proximité et prêt à être utilisé. 1.3 Ne pas utiliser un fût ou un autre contenant fermé comme table de coupe.	
		2. Plasma arc can injure and burn; point the nozzle away from yourself. Arc starts instantly when triggered. 2.1 Turn off power before disassembling torch. 2.2 Do not grip the workpiece near the cutting path. 2.3 Wear complete body protection.		2. L'arc plasma peut blesser et brûler; éloigner la buse de soi. Il s'allume instantanément quand on l'amorce. 2.1 Couper l'alimentation avant de démonter la torche. 2.2 Ne pas saisir la pièce à couper de la trajectoire de coupe. 2.3 Se protéger entièrement le corps.	
		3. Hazardous voltage. Risk of electric shock or burn. 3.1 Wear insulating gloves. Replace gloves when wet or damaged. 3.2 Protect from shock by insulating yourself from work and ground. 3.3 Disconnect power before servicing. Do not touch live parts.		3. Tension dangereuse. Risque de choc électrique ou de brûlure. 3.1 Porter des gants isolants. Remplacer les gants quand ils sont humides ou endommagés. 3.2 Se protéger contre les chocs en s'isolant de la pièce et de la terre. 3.3 Couper l'alimentation avant l'entretien. Ne pas toucher les pièces sous tension.	
		4. Plasma fumes can be hazardous. 4.1 Do not inhale fumes. 4.2 Use forced ventilation or local exhaust to remove the fumes. 4.3 Do not operate in closed spaces. Remove fumes with ventilation.		4. Les fumées plasma peuvent être dangereuses. 4.1 Ne pas inhaler les fumées. 4.2 Utiliser une ventilation forcée ou un extracteur local pour disperser les fumées. 4.3 Ne pas couper dans des espaces clos. Chasser les fumées par ventilation.	
		5. Arc rays can burn eyes and injure skin. 5.1 Wear correct and appropriate protective equipment to protect head, eyes, ears, hands and body. Button shirt collar. Protect ears from noise. Use welding helmet with the correct shade of filter.		5. Les rayons d'arc peuvent brûler les yeux et blesser la peau. 5.1 Porter un bon équipement de protection pour se protéger la tête, les yeux, les oreilles, les mains et le corps. Boutonner le col de la chemise. Protéger les oreilles contre le bruit. Utiliser un masque de soudeur avec un filtre de nuance appropriée.	
		6. Become trained. Only qualified personnel should operate this equipment. Use torches specified in the manual. Keep non-qualified personnel and children away.		6. Suivre une formation. Seul le personnel qualifié a le droit de faire fonctionner cet équipement. Utiliser exclusivement les torches indiquées dans le manuel. Le personnel non qualifié et les enfants doivent se tenir à l'écart.	
		7. Do not remove, destroy, or cover this label. Replace if it is missing, damaged, or worn.		7. Ne pas enlever, détruire ni couvrir cette étiquette. La remplacer si elle est absente, endommagée ou usée.	

CSA safety label